

RADIO & ELECTRONICS CONSTRUCTOR

JULY 1977

40p



sound
activated
switch



**ALSO
FEATURED**

SQUARE WAVE GENERATOR
(Blob-a-job No. 2)

Index Volume 30

NOEL M. MORRIS

**SEMICONDUCTOR
DEVICES**

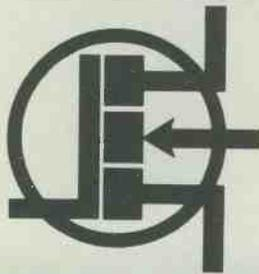

MACMILLAN BASIS BOOKS IN ELECTRONICS

SPECIAL OFFER

For a limited period

By arrangement with Messrs. MacMillan we are able to offer the above book at a special low price to readers of RADIO & ELECTRONICS CONSTRUCTOR.

Normal Price£4.35

SPECIAL OFFER PRICE.....£3.50

Saving 85p

Both prices include postage and packing

In this introduction to semiconductor devices, the author provides a comprehensive survey of modern active and non-active semiconductor technology. Without leaning too heavily on device physics, he explains device functions and then illustrates their use with typical circuits and applications.

Following a summary of the physical basis of semiconductor elements — in non-mathematical terms — a study of bipolar and field-effect transistors leads to considerations of monolithic integrated circuits. More advanced charge-coupled devices, semiconductor memories and optoelectronic devices are studied in some detail.

CONTENTS

1. Semiconductors
2. Basic Semiconductor Devices
3. Semiconductor Diodes and the Unijunction Transistor
4. Bipolar Junction Transistors, Amplifiers & Logic Gates
5. Field-Effect Transistors, Amplifiers and Logic Gates
6. Monolithic Integrated Circuits
7. Charge-coupled Devices
8. Semiconductor Memories
9. Thyristors and other Multilayer Devices
10. Optoelectronics

To: Data Publications Ltd., 57 Maida Vale, London W9 1SN

Please send me within 21 days copy/copies of

SEMICONDUCTOR DEVICES

I enclose Postal Order/Cheque for £.....

Name

Address

(Block Letters Please)

(We regret this offer is only available to readers in the U.K.)

RADIO & ELECTRONICS CONSTRUCTOR

JULY 1977

Volume 30 No. 12

Published Monthly (1st of Month)

First Published 1947

Incorporating The Radio Amateur

Editorial and Advertising Offices
57 MAIDA VALE LONDON W9 1SN

Telephone
01-286 6141

Telegrams
Databux, London

© Data Publications Ltd., 1977. Contents may only be reproduced after obtaining prior permission from the Editor. Short abstracts or references are allowable provided acknowledgement of source is given.

Annual Subscription: £6.00 (U.S.A. and Canada \$12.00) including postage. Remittances should be made payable to "Data Publications Ltd". Overseas readers please pay by cheque or International Money Order.

Technical Queries. We regret that we are unable to answer queries other than those arising from articles appearing in this magazine nor can we advise on modifications to equipment described. We regret that such queries cannot be answered over the telephone; they must be submitted in writing and accompanied by a stamped addressed envelope for reply.

Correspondence should be addressed to the Editor, Advertising Manager, Subscription Manager or the Publishers as appropriate.

Opinions expressed by contributors are not necessarily those of the Editor or proprietors.

Production.—Web Offset.

THE 'JUBILEE' A.M.-F.M. RECEIVER —Part 1 by Sir Douglas Hall, K.C.M.G.	726
NOVEL PRINTED CIRCUIT ASSEMBLY by T. E. Millsom	733
NEWS AND COMMENT	734
SQUARE WAVE GENERATOR by I. R. Sinclair (Special Series—Blob-a-job No. 2)	736
4-STEP CMOS SEQUENCE SWITCH (Suggested Circuit) by G. A. French	739
THE PARIS COMPONENTS SHOW A report on some of the interesting exhibits by David Gibson	742
SOUND ACTIVATED SWITCH by R. A. Penfold	744
SHORT WAVE NEWS—For DX Listeners by Frank A. Baldwin	750
CONSTRUCTOR'S CROSSWORD Compiled by J. R. Davies	752
SIMPLE QUADRAPHONIC AMPLIFIER—Part 2 by R. A. Penfold	753
CAN ANYONE HELP?	760
IN YOUR WORKSHOP—Readers' Hints	761
BOOK REVIEW	766
AMSAT—UK OSCAR COMMAND STATION by Arthur C. Gee	767
TRADE NEWS	768
INDEX VOLUME 30—August 1976 to July 1977	774
ELECTRONICS DATA No. 24 (For The Beginner—Automatic Gain Control)	iii

Published in Great Britain by the Proprietors and Publishers, Data Publications Ltd, 57 Maids Vale, London W9 1SN

The *Radio & Electronics Constructor* is printed by Swale Press Ltd.

THE AUGUST ISSUE WILL BE
PUBLISHED ON 1st AUGUST

SEMICONDUCTORS — COMPONENTS

DIODES

Type	Price	Type	Price	Type	Price	Type	Price
AA129	£0.08	BY100	£0.22	BY211	£0.48	OA91	£0.07
AA30	£0.09	BY107	£0.22	BY212	£0.48	OA95	£0.07
AA213	£0.16	BY105	£0.22	BY213	£0.40	OA182	£0.13
AA217	£0.16	BY114	£0.22	BY216	£0.41	OA200	£0.08
BA100	£0.10	BY124	£0.22	BY217	£0.38	OA202	£0.08
BA102	£0.32	BY126	£0.18	BY218	£0.38	SD10	£0.08
BA148	£0.16	BY127	£0.18	BY219	£0.38	SD19	£0.08
BA154	£0.32	BY128	£0.16	OA10	£0.36	IN34	£0.07
BA155	£0.14	BY130	£0.17	OA47	£0.08	IN34A	£0.07
BA156	£1.16	BY133	£0.21	OA70	£0.08	IN914	£0.06
BA173	£0.16	BY164	£0.81	OA79	£0.13	IN916	£0.06
BB104	£0.07	BY176	£0.78	OA81	£0.13	IN4148	£0.06
BA313	£0.07	BY208	£0.30	OA85	£0.13	IS44	£0.06
BAX16	£0.08	BY210	£0.45	DA90	£0.07	IS920	£0.06

SILICON RECTIFIERS

Type	Price	Type	Price	Type	Price	Type	Price
IS920	£0.06	IN4003	£0.08	IS020	£0.10	IS031	£0.26
IS921	£0.07	IN4004	£0.09	IS021	£0.11	IN5400	£0.14
IS922	£0.08	IN4005	£0.10	IS023	£0.13	IN5401	£0.15
IS923	£0.09	IN4006	£0.11	IS025	£0.14	IN5402	£0.16
IS924	£0.10	IN4007	£0.12	IS027	£0.16	IN5404	£0.17
IN4001	£0.61	IS015	£0.09	IS029	£0.20	IN5406	£0.21
IN4002	£0.07					IN5407	£0.26
						IN5408	£0.30

TRIACS

2 AMP T08 CASE			10 AMP T048 CASE		
Volts	No.	Price	Volts	No.	Price
100	TR12A/100	£0.31	100	TR10A/100	£0.77
200	TR12A/200	£0.51	200	TR10A/200	£0.92
400	TR12A/400	£0.71	400	TR10A/400	£1.12

6 AMP T068 CASE			10 AMP T048 CASE		
Volts	No.	Price	Volts	No.	Price
100	TR16A/100	£0.51	100	TR10A/100	£0.77
200	TR16A/200	£0.61	200	TR10A/200	£0.92
400	TR16A/400	£0.77	400	TR10A/400	£1.12

THYRISTORS

600mA T018 CASE			7 AMP T048 CASE		
Volts	No.	Price	Volts	No.	Price
10	THY600/10	£0.16	50	THY7A/50	£0.48
20	THY600/20	£0.18	100	THY7A/100	£0.81
30	THY600/30	£0.20	200	THY7A/200	£0.87
50	THY600/50	£0.22	400	THY7A/400	£0.82
100	THY600/100	£0.26	600	THY7A/600	£0.78
200	THY600/200	£0.38	800	THY7A/800	£0.92
400	THY600/400	£0.44			

1 AMP T08 CASE			10 AMP T048 CASE		
Volts	No.	Price	Volts	No.	Price
50	THY1A/50	£0.26	50	THY10A/50	£0.61
100	THY1A/100	£0.28	100	THY10A/100	£0.87
200	THY1A/200	£0.32	200	THY10A/200	£0.82
400	THY1A/400	£0.38	400	THY10A/400	£0.71
600	THY1A/600	£0.45	600	THY10A/600	£0.89
800	THY1A/800	£0.58	800	THY10A/800	£1.22

3 AMP T068 CASE			18 AMP T048 CASE		
Volts	No.	Price	Volts	No.	Price
50	THY3A/50	£0.28	100	THY18A/100	£0.58
100	THY3A/100	£0.30	200	THY18A/200	£0.82
200	THY3A/200	£0.33	400	THY18A/400	£0.77
400	THY3A/400	£0.42	600	THY18A/600	£0.90
600	THY3A/600	£0.80	800	THY18A/800	£1.39
800	THY3A/800	£0.85			

5 AMP T068 CASE			30 AMP T094 CASE		
Volts	No.	Price	Volts	No.	Price
50	THY5A/50	£0.38	50	THY30A/50	£1.18
100	THY5A/100	£0.48	100	THY30A/100	£1.43
200	THY5A/200	£0.60	200	THY30A/200	£1.83
400	THY5A/400	£0.87	400	THY30A/400	£1.79
600	THY5A/600	£0.89	600	THY30A/600	£3.50
800	THY5A/800	£0.81			

5 AMP T0220 CASE		
Volts	No.	Price
400	THY5A/400P	£0.87
600	THY5A/600P	£0.89
800	THY5A/800P	£0.81

SUPER UNTESTED PAKS

Pak No.	Qty.	Description	Order No.	Price
U50	100	Germ. gold bonded OA47 diode	16130	£0.60
U51	150	Germ. OA70/81 diode	16131	£0.60
U52	100	Silicon diodes 200mA OA200	16132	£0.60
U53	150	Diodes 78mA IN4148	16133	£0.60
U54	50	Sil rect top hat 750mA	16134	£0.60
U55	20	Sil rect stud type 3 amp	16135	£0.60
U56	50	400mV zeners D07 case	16136	£0.60
U57	30	PNP trans BC107/8 plastic	16137	£0.60
U58	30	PNP trans BC177/178 plastic	16138	£0.60
U59	25	PNP TO18 2N697/2N1711 silicon	16139	£0.60
U60	25	PNP TO18 2N2905 silicon	16140	£0.60
U61	30	PNP TO18 2N706 silicon	16141	£0.60
U62	25	PNP BF505/51	16142	£0.60
U63	30	PNP plastic 2N3906 silicon	16143	£0.60
U64	30	PNP plastic 2N3905 silicon	16144	£0.60
U65	30	Germ. OZ71 PNP	16145	£0.60
U66	15	Plastic power 2N3055 NPN	16146	£1.20
U67	10	TD3 metal 2N3055 NPN	16147	£1.20
U68	20	Unijunction trans IS43	16148	£0.60
U69	10	1 amp SCR TO39	16149	£1.20
U70	8	3 amp SCR TO66 case	16150	£1.20

Code Nos. mentioned above are given as a guide to the type of device in the pak. The devices themselves are normally unmarked.

COMPONENT PAKS

Pak No.	Qty.	Description	Order No.	Price
C1	200	Resistor mixed value approx (count by weight)	16164	£0.60
C2	150	Capacitors mixed value approx. (count by weight)	16165	£0.60
C3	50	Precision resistors. Mixed values	16166	£0.60
C4	80	1W resistors mixed preferred values	16167	£0.60
C5	5	Pieces assorted ferrite rods	16168	£0.60
C6	2	Tuning ganks. MW/LW VHF	16169	£0.60
C7	1	Pack wire 50 m ters assorted colours single strand	16170	£0.60
C8	10	Reed switches	16171	£0.60
C9	3	Micro switches	16172	£0.60
C10	15	Assorted pots	16173	£0.60
C11	5	Metal jack sockets 3 x 3.5mm 2 x standard switch types	16174	£0.60
C12	30	Paper condensers preferred types mixed values	16175	£0.60
C13	20	Electrolytic trans. types	16176	£0.60
C14	1	Pak assorted hardware — nuts/bolts, gromets, etc.	16177	£0.60
C15	5	Mains slide switches assorted	16178	£0.60
C16	20	Assorted tag strips and panels	16179	£0.60
C17	15	Assorted control knobs	16180	£0.60
C18	4	Rotary wave change switches	16181	£0.60
C19	2	Relays P-4V operating	16182	£0.60
C20	1	Pak. copper laminate approx 200 sq. in.	16183	£0.60
C21	15	Assorted fuses 100mA-5 amp	16184	£0.60
C22	50	Metres PVC sleeving assorted size	16185	£0.60
C23	60	AND COLOUR	16188	£0.60
C24	25	Presets assorted type and value	16186	£0.60
C25	30	Metres stranded wire assorted colours	16187	£0.60

SLIDER PAKS

Pak No.	Qty.	Description	Order No.	Price
S1	6	Slider potentiometers, mixed values	16190	£0.60
S2	6	Slider potentiometers, all 470 ohms	16191	£0.60
S3	6	Slider potentiometers, all 10k ohms	16192	£0.60
S4	6	Slider potentiometers, all 22k ohms	16193	£0.60
S5	6	Slider potentiometers, all 47k ohms	16194	£0.60
S6	6	Slider potentiometers, all 47k log	16195	£0.60

CERAMIC PAKS

Containing a range of first quality miniature ceramic capacitors. Unrepeatable values.

Pak No.	Qty.	Description	Order No.	Price
MC1	24	miniature ceramic capacitors, 3 of each value — 22pF, 27pF, 33pF, 39pF, 47pF, 68pF, and 82pF	16160	£0.60
MC2	24	miniature ceramic capacitors, 3 of each value — 100pF, 120pF, 150pF, 180pF, 220pF, 270pF, 330pF and 390pF	16161	£0.60
MC3	24	miniature ceramic capacitors, 3 of each value — 470pF, 560pF, 680pF, 820pF, 1,000pF, 1,500pF, 2,200pF and 3,300pF	16162	£0.60
MCA	21	miniature ceramic capacitors, 3 of each value — 4,700pF, 6,800pF, 0.01µF, 0.015µF, 0.022µF, 0.033µF, 0.047µF	16163	£0.60

LINEAR PAKS

Manufacturer's "Fall Outs" which include Functional and part-Functional Units. These are classed as "out of spec" from the maker's very rigid specifications, but are ideal for learning about ICs and experimental work.

U721-30 Assorted Linear Types, 709, 741, 747, 748, 710, 588, etc.

ORDER No. 16227 £1.50

U755D FM STEREO DECODER
5 ICs 76110 equivalent to MC1310P-MA767. Data supplied with pak.
ORDER No. 16229 £1.50

U76A AUDIO POWER OUTPUT AMPLIFIERS
8 assorted types. SL403, 76013, 76003, etc. Data supplied with pak.
ORDER No. 16228 £1.00

74 SERIES PAKS

Manufacturer's "Fall Outs" which include Functional and part-Functional Units. These are classed as "out of spec" from the maker's very rigid specifications, but are ideal for learning about ICs and experimental work.

74G-100 Gates assorted 7400-01-04-10-50-60, etc.

ORDER No. 16224 £1.20

74F-50 Flip-Flops assorted 7470-72-73-74-76-104-109, etc.
ORDER No. 16225 £1.20

74M-30 MSI. Assorted Types. 7441-47-90-154, etc.
ORDER No. 16226 £1.20

VEROBOARDS PAKS

VB1—Approx. 30s in various sizes. All 0.1in matrix.
ORDER No. 16199 50p

VB2—Approx. 30s in various sizes. 0.15in matrix.
ORDER No. 16200 60p

ELECTROLYTIC PAKS

A range of paks each containing 18 first quality, mixed value miniature electrolytics.

EC1—Values from 0.47µF to 10µF.
ORDER No. 16201 60p

EC2—Values from 100µF to 100µF.
ORDER No. 16202 60p

EC3—Values from 100µF to 680µF.
ORDER No. 16203 60p

C280 CAPACITOR PAK

75 Mullard C280 capacitors, mixed values ranging from 0.01µF to 2.2µF complete with identification sheet.
ORDER No. 16204 £1.20

CARBON RESISTOR PAKS

These paks contain a range of Carbon Resistors, assorted into the following groups:

R1-60 mixed 1W 100-820 ohms.
ORDER No. 16213 60p

R2-60 mixed 1W 1-8.2k
ORDER No. 16214 60p

R3-60 mixed 1W 10-82k
ORDER No. 16215 60p

R4-60 mixed 1W 100-8205
ORDER No. 16216 60p

R5-40 mixed 1W 100-820
ORDER No. 16217 60p

R6-40 mixed 1W 1-8.2k
ORDER No. 16218 60p

R7-40 mixed 1W 10-82k
ORDER No. 16219 60p

R8-40 mixed 1W 100-820k
ORDER No. 16220 60p

R9-60 mixed 1W 1-10M
ORDER No. 16230 60p

R10-40 mixed 1W 1-10M
ORDER No. 16231 60p

WORLD SCOOP JUMBO SEMICONDUCTOR PAK

Transistors, Germ. and Silicon Rectifiers, Diodes, Triacs, Thyristors, ICs and Zeners.

ALL NEW AND CODED

Approx. 100 pieces. Offering the amateur a fantastic bargain PAK and an enormous saving — identification and date sheet in every pak.
ORDER No. 16222 £2.25

ORDERING
Please word your orders exactly as printed, not forgetting to include our part number.

VAT
Add 12½% to prices marked*
Add 8% to others excepting those marked†. These are zero rated.

POSTAGE
Postage and packing add 25p unless otherwise shown. Add extra for air-mail. Minimum order £1.

Just a selection from our huge stocks!

SEE OUR 1977 CATALOGUE

126 pages packed with valuable information

ORDER NOW ONLY 50p plus 15p p&p

BI-PAK

Dept. R.C.8, P.O. Box 6, Ware, Herts

COMPONENTS SHOP: 18 BALDOCK STREET, WARE, HERTS

THE 'NUTS & BOLTS' OF THOSE PROJECTS!

TRANSFORMERS

MINIATURE MAINS Pri240V
with two independent secondary windings.

No.	Type	Price
2024 MT280	0-6v, 0-6v RMS	£1.30*
2025 MT150	0-12v, 0-12v RMS	£1.30*

MINIATURE MAINS Pri 240v
Secondary

No.	Secondary	Price
2021	6v-0-6v 100mA	90p*
2022	9v-0-9v 100mA	90p*
2023	12v-0-12v 100mA	90p*

1 amp MAINS Pri 240v

No.	Secondary	Price	p&p
2026	6v-0-6v 1 amp	£2.70*	30p
2027	9v-0-9v 1 amp	£2.20*	30p
2028	12v-0-12v 1 amp	£2.60*	30p
2029	15v-0-15v 1 amp	£2.75*	30p
2030	30v-0-30v 1 amp	£3.45*	30p

STANDARD MAINS Pri 240v
Multi-tapped secondary mains transformers available in 1/2 amp, 1 amp and 2 amp current rating. Secondary taps are 0-19-25-33-40-50v.

Volts available by use of taps:
4, 7, 8, 10, 14, 15, 17, 19, 25, 31, 33, 40, 50, 25-0-25 volts.

No.	Rating	Price	p&p
2031	1/2 amp	£3.42*	30p
2032	1 amp	£4.40*	50p
2033	2 amp	£5.45*	80p

AUDIO OUTPUT Pri 1.2k Secondary 5 ohms
200mW Dimensions 20 x 16 x 15

Order no. 2037 £0.25*

MINIATURE INTER/DRIVER
Pri 20k Secondary 1k Ratio 5:1

Order no. 2038 £0.23*

LT710 MIN INPUT

Pri 100k Secondary 1k 15 x 13 x 13mm

Order no. 3051 £0.42*

LT711 MIN DRIVER

Pri 10k Secondary 2k-C.T. 15 x 13 x 13mm

Order no. 2040 £0.35*

LT712 MIN OUTPUT

Pri 500 ohm Secondary 8 ohm 100mW 15 x 13 x 13mm

Order no. 2041 £0.28*

LT717 MIN INPUT

Pri 150k Secondary 1k 20 x 15 x 15

Order no. 2042 £0.52*

LT719 MIN INPUT

Pri 20k Secondary 1k 20 x 15 x 15mm

Order no. 2043 £0.32*

LT722 MIN DRIVER

Pri 10k Secondary 2k-C.T. 20 x 15 x 15mm

Order no. 2044 £0.32*

LT724 MIN OUTPUT

Pri 1.2-C.T. Secondary 3.2 & 8 ohm 200mW

Dimensions 20 x 15 x 15mm

Order no. 2045 £0.38*

LT726 MIN OUTPUT

Pri 600 ohm Secondary 3.2 & 8 ohm 200mW

Dimensions 20 x 15 x 15mm

Order no. 12048 £0.38*

LT728 MIN DRIVER

Pri 1k C.T. Secondary 500 ohm C.T.

Dimensions 25 x 20 x 20mm

Order no. 2047 £0.43*

LT729 MIN OUTPUT

Pri 200 ohm C.T. Secondary 3.2 & 8 ohm 400mW

Dimensions 25 x 20 x 20mm

Order no. 2048 £0.39*

LT730 MIN OUTPUT

Pri 500 ohm C.T. Secondary 3.2 & 8 ohms 500mW

Order no. 2049 £0.42*

L.E.D.'s

Type	Size	Order No.	Colour	Price
TIL209	.125"	1501	RED	.12p
TIL211	.125"	1502	GREEN	.25p
TIL213	.125"	1503	YELLOW	.25p
FLV115	.2"	1504	RED	.12p
FLV310	.2"	1505	GREEN	.25p
FLV410	.2"	1506	YELLOW	.25p

2nd Grade L.E.D.'s

A pack of standard sizes and colours which fall to perform to their very rigid specification, but which are ideal for experiments.

Order no. 1507 £0.90

L.E.D. CLIPS

Pack of 5	Size	Order no.	Price
Pack of 5	.125"	1508/125	15p
Pack of 5	.2"	1508/2	15p

NUTS & BOLTS

BA BOLTS — packs of B.A. Threaded cadmium plated screws, slotted cheese head. Supplied in multiples of 100.

Type	No.	Price	Type	No.	Price
1" OBA	839	£1.50	1" 4BA	846	£0.51
1" OBA	840	£0.83	1" 4BA	846	£0.38
1" 2BA	842	£0.69	1" 4BA	847	£0.33
1" 2BA	843	£0.54	1" 6BA	848	£0.50
1" 2BA	844	£0.83	1" 6BA	849	£0.30
			1" 8BA	850	£0.33

BA NUTS — Packs of cadmium plated full nuts in multiples of 100.

Type	No.	Price	Type	No.	Price
OBA	855	£0.90	4BA	857	£0.42
2BA	856	£0.60	6BA	858	£0.36

BA WASHERS — flat cadmium plated plain stamped washers supplied in multiples of 100.

Type	No.	Price	Type	No.	Price
OBA	859	£0.20	4BA	861	£0.15
2BA	860	£0.15	6BA	862	£0.12

SOLDER TAGS — hot tinned supplied in multiples of 100.

Type	No.	Price	Type	No.	Price
OBA	851	£0.42	4BA	853	£0.30
2BA	852	£0.36	6BA	854	£0.30

INSTRUMENT CASES. In two sections, black vinyl covered top and sides and bezel.

No.	Length	Width	Height	Price
155	8"	5 1/2"	2"	£1.62*
156	11"	6"	3 1/2"	£2.12*
157	6"	4 1/2"	2 1/2"	£1.30*
158	9"	5 1/2"	2 1/2"	£1.76*

ALUMINIUM BOXES. Made from bright ali., folded construction each box complete with half inch deep lid and screws.

No.	Length	Width	Height	Price
159	5 1/2"	2 1/2"	1 1/2"	£0.62*
160	4"	2 1/2"	1 1/2"	£0.62*
161	4"	2 1/2"	1 1/2"	£0.62*
162	5 1/2"	4"	1 1/2"	£0.70*
163	4"	2 1/2"	1 1/2"	£0.64*
164	3"	2 1/2"	1 1/2"	£0.44*
165	7"	5"	2 1/2"	£1.04*
166	3"	6"	3"	£1.32*
167	6"	4"	2"	£0.86*

BRIDGE RECTIFIERS

Type	Order No.	Price
50V RMS	BR1/50	£0.28
100V RMS	BR1/100	£0.30
200V RMS	BR1/200	£0.32
400V RMS	BR1/400	£0.36*

SILICON 2 AMP

Type	Order No.	Price
50v	BR2/50	£0.46
100v	BR2/100	£0.48
200v	BR2/200	£0.52
400v	BR2/400	£0.58
1000v	BR2/1000	£0.68

FUSE HOLDERS & FUSES

Description	Order No.	Price
20mm x 5mm chassis mounting	506	£0.07*
1 1/2" x 1/2" chassis mounting	507	£0.10*
1 1/2" car inline type	508	£0.20*
Panel mounting 20mm	509	£0.22
Panel mounting 1 1/2"	510	£0.24

QUICK BLOW 20mm

Type	No.	Type	No.	Price	
150mA	611	1A	615	3A	619
250mA	612	1.5A	616	4A	620
500mA	613	2A	617	5A	621
800mA	614	2.5A	618	ALL 5p EACH	

ANTI-SURGE 20mm

Type	No.	Type	No.	Price	
100mA	622	1A	625	2.5A	628
250mA	623	2A	626	3.15A	629
500mA	624	1.6A	627	5A	630

QUICK BLOW 1 1/2"

Type	No.	Type	No.	Price	
250mA	631	500mA	632	800mA	634
				ALL 7p EACH	

Type	No.	Type	No.	Price	
1A	635	2.5A	638	4A	641
1.6A	636	3A	639	5A	642
2A	637	ALL 5p EACH			

Just a selection from our huge stocks!

SEE OUR 1977 CATALOGUE

126 pages packed with valuable information

ORDER NOW ONLY 50p

plus 15p p&p

SWITCHES

Description	No.	Price
D.P.D.T. miniature slide	1973	£0.10*
D.P.D.T. standard slide	1974	£0.12*
Toggle switch S.P.S.T.		
1/2 amp 250v AC	1975	£0.33*
Toggle switch D.P.D.T.		
1 amp 250v AC	1976	£0.36*
Rotary ON/OFF mains switch	1977	£0.42*
Push switch — Push to make	1978	£0.13*
Push switch — Push to break	1979	£0.18*

ROCKER SWITCH Colour

Colour	No.	Price
RED	1980	£0.22*
BLACK	1981	£0.22*
WHITE	1982	£0.22*
BLUE	1983	£0.22*
YELLOW	1984	£0.22*
LUMINOUS	1985	£0.22*

Description	No.	Price
Miniature S.P.S.T. toggle		
2 amp 250v AC	1958	£0.50*
Miniature S.P.S.T. toggle		
2 amp 250v AC	1959	£0.55*
Miniature D.P.D.T. toggle		
2 amp 250v AC	1960	£0.65*
Miniature D.P.D.T. toggle centre off — 2 amp 250v AC	1961	£0.85*
Push button S.P.S.T. 2 amp 250v AC	1962	£0.65*
Push button S.P.S.T. 2 amp 250v AC	1963	£0.68*
Push button D.P.D.T. 2 amp 250v AC	1964	£0.80*

MIDGET WAFER SWITCHES

Single-bank wafer type — suitable for switching at 250v AC 100mA or 160v DC in non-reactive loads make before-break contacts. These switches have a spindle 0.25" dia and 30° indexing.

Description	Order No.	Price
2 pole 12 way	1965	£0.48*
2 pole 6 way	1966	£0.48*
3 pole 4 way	1967	£0.48*
4 pole 3 way	1968	£0.48*

MICRO SWITCHES

Description	Order No.	Price
Plastic button gives simple on-off action		
Rating 10 amps 250v AC	1969	£0.20
Button gives 1 pole change over action		
Rating 10 amp 250v AC	1970	£0.25

DISPLAYS

LED Type	No.	Price
BDL707 .3" single	1510	£0.80
BDL747 .6" single	1511	£1.50
BDL727 .5" double	1512	£1.80

COLD CATHODE ITT 5087 ST

Side viewing indicator tubes. Displays 0-9 and decimal points. Wide viewing angle — operates from 180v with 16k series anode resistors — character height 16.5mm pin connections supplied.

Order No. 1513 Price £0.60

VOLTAGE REGULATORS

Positive Regulators TO220 case	Price
MVR 7805 5v	£1.25
MVR 7815 15v	£1.25
MVR 7812 12v	£1.25
MVR 7824 24v	£1.25

Negative Regulators TO220 case	Price
MVR 7905 5v	£1.85
MVR 7915 15v	£1.85
MVR 7912 12v	£1.85
MVR 7924 24v	£1.85

ORDERING

Please word your orders exactly as printed, not forgetting to include our part number.

VAT

Add 12 1/2% to prices marked*
Add 8% to others excepting those marked. These are zero rated.



PRECISION IN YOUR HAND!

with the PRECISION PETITE miniature electric drills

The P1 drill illustrated is excellent for speedy work on p.c. boards, light metalwork and plastics. It operates from a 9-14v. d.c. source @ 2 amps and turns at 10,000 r.p.m. with 120 cmg. torque. A wide range of accessories is available.

ALSO the New P2 drill . . . more powerful, faster and of larger capacity has 4 collets for 0 to 3.5 mm. tool shanks, long ball bearing shaft and powerful motor running at 12,000 r.p.m. with 320 cmg. torque 12v d.c. @ 3 amps.



PRICES inc V.A.T.		
P1S Drill Stand	5.13	35 p.p.
P1 Drill only	9.67	35 p.p.
Flexible Drive Shaft	5.94	25 p.p.
Transformer	7.56	70 p.p.
Variable Speed Transformer	9.50	70 p.p.
S.30 Kit (Drill with 30 tools)	19.39	85 p.p.
Kit complete	38.02	1.15 p.p.
P2 Drill only	16.50	65 p.p.
Replacement accessories		40p each

Postage for spares (any quantity)..... 20p
Send 9in x 4in SAE for illustrated leaflets and order form

Sole UK Distributors



PRECISION PETITE LTD

119a HIGH STREET

TEDDINGTON MIDDLESEX TW11 8HG

TEL: 01-977 0878 · 24 Hour recorded service

LATEST BOUND VOLUME No. 29



of
"Radio & Electronics
Constructor"

FOR YOUR LIBRARY

NOW AVAILABLE

Comprising
776 pages
inc. index

AUGUST 1975
to JULY 1976

PRICE £3.10 P&P 90p

BOUND VOLUME No. 27 (August 1973 to July 1974)
BOUND VOLUME No. 28 (August 1974 to July 1975)

PRICE £2.40 p. & p. 90p
PRICE £2.75 p. & p. 90p

Limited number of these volumes still available

We regret all other volumes are now completely sold out.
Available only from

DATA PUBLICATIONS LTD., 57 MAIDA VALE, LONDON, W9 1SN

Are you BLOB-A-JOBING Yet?

The Technique of inserting components on one side of a board and soldering on the other is done for reasons which are now completely out of date; Namely this technique was established originally because heavy and bulky components were used. This no longer applies and has big disadvantages, the circuit is impossible to follow unless the board is continually turned over to inspect each side, its difficult to work on both sides of the board and soldering basically needs three hands. A common fault is to mount both leadout wires on the same track.

Blob-Boards give you the modern, low cost, easy way to build circuits. Blob-Boards are roller tinned circuit boards on which each roller tinned copper track is identified by the letter and or number system. Simply tin the end of the component, butt the component lead against the roller tinned track, apply a blob of solder and the component is biobbed into place. All construction is from one side, component location could not be simpler, soldering is much easier, sub-circuits can be tested, then assembled together, the plain side of the Blob-Board is free and so the Blob-Board can be mounted flush on case walls. And they can be re-used, simply apply a soldering iron to the Blob and remove the component.

Last months Blob-a-Job was a "Voltage Stabiliser",
This months Blob-a-Job is a "Square wave generator and signal injector"

Both these projects are built on 2V5 Blob-Board.
Next months Blob-a-Job, well thats a secret,
but its built on a 2-IC Blob-Board.

Next months Blob-a-Job, well that's a secret,
but it's built on a 2-IC Blob-Board.

As
a special
offer to
Radio and Electronics
Constructor readers

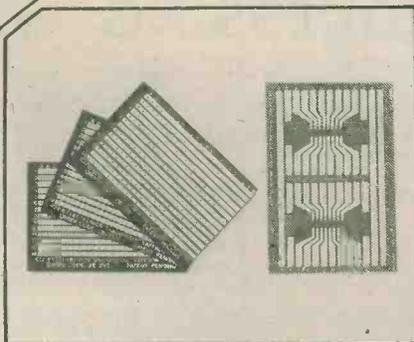

Buy pack of 3 2V5 Blob-Boards
and Get 1 21C Blob-Board Free
Please rush me

.....Packs of 3 2V5 + My Free 21C Blob
For only £0.62 per pack of 3.
Please add 20p for Post + VAT for all orders

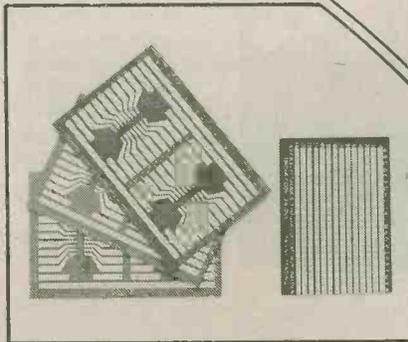

Buy pack of 3 2-IC Blob-Board
and Get 1 2V5 Blob-Board Free.
Please rush me

.....Packs of 3 2-IC + My Free 2V5 Blob
For only £1.01 per pack of 3.
Please add 20 for Post + VAT for all orders

All goods are ex-stock delivery. Please enclose cheque,
postal order payable to PB Electronics (Scotland) Ltd.
Offer Available from All Good Component Stockists. Save on Post!



P.B. Electronics (Scotland) Ltd.
57 High Street, Saffron Walden, Essex CB10 1AA England.
Telephone: Saffron Walden (0799) 22876 Telex: 817185.

**DISCO AMP?
POWER SUPPLY?
TEST EQUIPMENT?**

vero

VERO have a case to suit your needs.

VEROPAK CASES are available in five sizes. They are manufactured from P.V.C. clad steel with 16 S.W.G. aluminium front panels, anodised to a very high standard.

VEROPAK CASES were designed for industrial instrument use. They are a strong, attractive housing that will protect your delicate circuits for a lifetime.

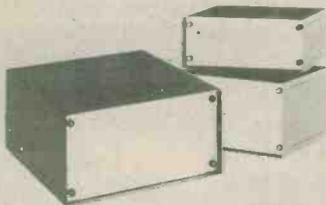

Send for our booklet which describes Veropak cases, Veroboard, Pins, Tools, Plastic cases etc. S.A.E. 7" x 9" plus 10p to:-

**VERO ELECTRONICS LTD. RETAIL DEPT.
INDUSTRIAL ESTATE, CHANDLERS FORD, HANTS. SO5 3ZR**



**SUPER SAVINGS
FOR THE HOME
CONSTRUCTOR**

**Goldring CK2
BELT DRIVE TURNTABLE
CONSTRUCTION KIT**

Complete with SAU2 arm, template and easy-to-follow instructions. Ready for operation in a short time.

**A FEW OF THE
MANY BIG FEATURES**

- Wow Flutter 0.15% peak
- Rumble -60dB weighted
- Removeable headshell
 - Viscouse damped cueing device
- Easily adjusted tracking force and bias setting
 - Two speed, 16 pole synchronous motor
- Dimensions 37.8 x 28.3cms

**BRAND NEW
IN SEALED CARTONS
12 MONTHS GUARANTEE**

OUTSTANDING VALUE
R.R.P. £31.50

**OUR PRICE
£16.95**

(+ £1.50 p/p & ins)

Plinth, cover and cartridge available, P.O.A.
Call in or send a cheque, P.O., M.O. or Access, Barclaycard American Express or Diners Club number.

Lion House 

227 Tottenham Court Road, London W.1. Tel 01-580 7383



**UNDERSTAND DATA
PROCESSING**

DATA PROCESSING, by Oliver & Chapman, is now in its Third Edition — first published 1972.

200 pages 9³/₄" x 6³/₄" **PRICE £2.50**
Inclusive of postage.

The primary aim of this outstanding manual is to provide a simplified approach to the understanding of data processing — (previous knowledge of the subject is not necessary).

The 40 chapters and appendices cover the following topics: Introduction to Data Processing; Organisation and Methods; Conventional Methods; Introduction to EDP and Computers; Hardware; Computer Files; Data Collection and Control; Programming and Software; Flowcharts and Decision Tables; Systems Analysis; Applications; Management of EDP, etc.

Available from:

D.P. PUBLICATIONS
4 AMPORT CLOSE, WINCHESTER, HANTS SO22 6LP

Stirling Sound

POWER AMPLIFIERS

at stated o/p powers ± 1 dB

- SS.103 3 watt r.m.s. mono. Uses one I.C. protected against short circuit £2.33
- SS.103-3 Stereo version — two I.C.s £4.33
- SS.105 5 w. r.m.s. into 3 Ω , using 12V £3.49
- SS.110 10 watts r.m.s. using 24V and 4 ohm load £4.05
- SS.120 20 watts r.m.s. into 4 ohms, using 34V £4.61
- SS.140 40 watts R.M.S. into 4 ohms using 45 volts supply unit such as SS.345 £4.99
- SS.1100 100 watts R.M.S. with heatsink flange, built protection against short-circuiting £10.43
- SS.1100/H As SS.1100 but with full size heatsink £11.82

TONE CONTROL/PRE-AMPS

- SS.100 Active stereo tone control, ± 15 dB on bass and treble £3.00
- SS.101 Stereo pre-amp for ceramic cartridges, etc. Passive tone control details supplied £2.33
- SS.102 Stereo pre-amp for low output magnetic P.U.s. R.I.A.A. corrected £4.04

UNIT ONE

Stereo pre-amp and active tone-control ± 15 dB treble and bass. Vol./balance/treble/bass £9.00

UNIT TWO

As Unit One, but for modern mag. pick-ups. R.I.A.A. corrected £12.43

F.M. TUNING

- SS.201 Front end tuner, slow geared drive, two gang. A.F.C. facility. Tunes 88-108 MHz £5.90
- SS.202 I.F. amp can take meter and A.F.C. facilities £3.46
- SS.203 Phase lock loop Stereo Decoder £4.19
- SS.203-1 Coil-type stereo decoder Neg. earth with I.C. £3.08
- SS.203-3 Coil-type Transistor. Pos. earth £2.50

POWER UNITS

With 13-15 volt take-off points on all models except SS.312. Off load voltages.

- | | | |
|--------|--------|--------|
| SS.312 | 12V/1A | £6.35 |
| SS.318 | 18V/1A | £6.54 |
| SS.324 | 24V/1A | £7.27 |
| SS.334 | 34V/2A | £8.31 |
| SS.345 | 45V/2A | £9.98 |
| SS.350 | 50V/2A | £10.35 |
| SS.370 | 70V/2A | £14.63 |

SS.310/50 Stabilised power supply; output variable from 10V to 50V/2A. Built-in protection against shorting £16.69

SS.300 Power stabilising unit 10.50V adjustable for adding to unstabilised supplies. Built-in protection against shorting £5.02

SPECIAL TERMS FOR QUANTITY BUYERS.
UK AND OVERSEAS TRADE ENQUIRIES INVITED

PAY THE PRICE YOU READ

All prices shown include V.A.T. and post and packing charges so as to make ordering easy. When you buy in person from our shop, cost of p&p. is deducted.



**A
100
WATT R.M.S.
POWER
AMPLIFIER**

**A
SPECIAL
70V
SUPPLY UNIT**

YOURS FOR £24.20

including V.A.T. and cost of p/p

At Stirling Sound, we design, make and sell from our famous QV (Quality and Value) Modules in our own factory. With over 25 years of continuous selling direct to the public, we know how to give value second to none. Was there ever better value than this? Look at our 100 watt R.M.S. amplifier with full size heatsink (SS.1100 H) and 70 volt/2A power unit with low volt (13-15V) take off point for pre-amp etc. This robust assembly makes an even domestic hi-fi where low conversion factor loudspeakers are used.

Bought separately, SS.1100 costs £10.43, the large heatsink £1.39, SS.370, £14.63 — total £26.45. Ordered together the cost comes to £24.20.

- Power output 100 watts R.M.S. into 4 ohms
- Frequency range 10 Hz to 50 KHz ± 1 dB
- Sensitivity 500 mV for full output
- Distortion 0.01% at half power
- S/N Ratio Better than 75dB
- Power requirements 70 volts (i.e. SS.370)
- Size (SS.1100) 5 x 3.5 x 1.25 inches sink.
- SS.1100 incorporates protection against shorting; SS.370 has low volt take off point (13-15V)

You save £2.25!

WHEN ORDERING make cheques/money orders crossed, payable to BI-PRE-PAK LTD. Use separate sheet of paper if you prefer not to cut out the coupon but quote DEPT RC7.

USE THE COUPON TO AVOID DELAY

STIRLING SOUND, 37 VANGUARD WAY, SHOEBURYNNESS, ESSEX

Stirling Sound

Mail Orders to DEPT. RC7
37 VANGUARD WAY
SHOEBURYNNESS, ESSEX
Telephone: Shoeburynness (03708) 5543

Personal Shoppers
220-240 West Road Telephone:
Westcliff-on-Sea, Essex. 0702-351048
Open all day Saturdays

Please supply:

.....
.....
.....
.....

NAME

ADDRESS

for which I enclose cheque/money order £.....

R.C.7

TRADE COMPONENTS

JUST A FEW BARGAINS ARE LISTED - SEND STAMPED ADDRESSED ENVELOPE FOR A QUOTE ON OTHER REQUIREMENTS. PAY A VISIT. OVER 90% OF STOCK BELOW QUANTITY WHOLESALE PRICE. ALL PRICES INCLUDE THE ADDITIONAL DISCOUNT IN LIEU OF GUARANTEE. CHEQUES CLEARED BEFORE DESPATCH

Goods sent at customer's risk, unless sufficient payment for registration (1st class letter post) or compensation fee (parcel post) included.

VALVE BASES	
Printed circuit B9A-B7G	3p
Chassis B7-B7G	9p
Shrouded chassis B7G-B9A-B8A	10p
Octal chassis B12A tube	10p

Speaker 6" x 4" 5 ohm ideal for car radio 70p

TAG STRIP - 6 way 3p	5 x 50pF or 2 x 220pF
9 way Single 1p	trimmers 20p

BOXES - Grey polystyrene 61 x 112 x 31mm, top secured by 4 self tapping screws 32½p

Clear perspex sliding lid, 46 x 39 x 24mm 10p
 ABS, ribbed inside 5mm centres for P.C.B., brass corner inserts, screw down lid, 50 x 100 x 25mm orange 48p; 80 x 150 x 50mm; black 70p; 109 x 185 x 60mm black £1.10

ALUMINIUM			
2 3/4" x 5 1/4" x 1 1/2"	45p	4" x 2 3/4" x 1 1/2"	45p
4" x 4" x 1 1/2"	45p	4" x 2 1/2" x 2"	44p
10" x 4 1/2" x 3"	£1.02	12" x 5" x 3"	£1.20
10" x 7" x 3"	£1.22		

SWITCHES			
Pole	Way	Type	
4	2	Sub. Min. Slide	18p
6	2	Slide	20p
1	3	13 amp rotary	6p
2	1	2 Amp 250V A.C. rotary	20p
2	3	Miniature Slide	16p

S.P.S.T. 10 amp 240v. white rocker switch with neon. 1" square flush panel fitting 20p
 S.P.S.T. dot 13 amp, oblong, push-fit, rocker 15p

Sidleen/AFA Very High Security barrel Key Switch. 2 tubular keys £1.50

AUDIO LEADS	
3 pin din to open end, 1 1/2 yd twin screened	35p
Phono to Phono plug, 6ft.	35p

COMPUTER & AUDIO BOARDS/ASSEMBLIES
 VARYING CONTENTS INCLUDE ZENER, GOLD BOND, SILICON, GERMANIUM, LOW AND HIGH POWER TRANSISTORS AND DIODES, HI STAB RESISTORS, CAPACITORS, ELECTROLYTICS, TRIMPOTS, POT CORES, CHOKES ETC.

3lb for 85p + £1.00 post and packing
 7lb for £1.95 + £1.40 post and packing

1k horizontal preset with knob	3p	3" Tape Spools	3p
		1" Terry Clips	4p
		12 Volt Solenoid	30p

TV KNOB
 Dark grey plastic for recessed shaft (quarter inch) with free shaft extension 5p

ENM Ltd. cased 7-digit counter 2 1/4 x 1 3/4 x 1 1/4" approx. 12V d.c. (48 a.c.) or mains 75p

ZM1162A INDICATOR TUBE
 0-9. Inline End View. Rectangular Envelope 170V 2.5M/A £1

REGULATED TAPE MOTOR
 9v d.c. nominal approx 1 1/2" diameter 60p

12v 8 amp Transformer £2.50 (p&p £1.00)
 Ferric Chloride, Anhydrous mil. spec. 1lb bag 40p

Car type panel lock and key 40p
 18 volt 4 amp charger, bridge rectifier 79p
 GC10/4B £3.00

Aluminium Knobs for 1/4" shaft. Approx. 5/8" x 3/8" with indicator Pack of 5. 50p

RESISTORS	
1/8-1/4 1/2 watt	1p
1 watt	2p
Up to 15 watt wire wound	6p
1 or 2% five times price.	
Cinch 8 way std 0.15 pitch edge connector	20p

Semiconductor Data Book 171 pages. Covers Japanese types 25A12 through to 2SD335. Type/connection/parameter details £1.50
 No VAT

POTS
 Log or Lin, single or dual, switched carbon or wire-wound, rotary or slider. All types 16p
 1.5m Edgetype 3p

Skeleton Presets
 Slider, horizontal or vertical standard or submin. 5p

THERMISTORS	
VA1008, VA1034, VA1039, VA1040, VA1055, VA1066, VA1082, VA1100, VA1077, VA1005.	10p
	15p

RELAYS
 12 volt S.P.C.O octal mercury wetted high speed 40p
 P.O. 30J0 type, 1,000 OHM coil, 4 pole c/o 40p
 Mains or 12v d.p.c.o heavy duty octal 50p
 3.5mm metal stereo plug 20p

JAP 4 gang min. sealed tuning condensers 20p

ELECTROLYTICS MFD/VOLT. Many others in stock										
	70-	200-	300-	450-						
Up to 10V 25V 50V 75V 100V 250V 350V 500V MFD										
10	4p	5p	6p	8p	10p	12p	16p	20p		
25	4p	5p	6p	8p	10p	15p	18p	20p		
50	4p	5p	6p	9p	13p	18p	25p			
100	5p	6p	10p	12p	19p	20p				
250	9p	10p	11p	17p	28p		85p	£1		
500	10p	11p	17p	24p	45p					
1000	13p	22p	40p	75p		£1.50				
2000	23p	37p	45p							

As total values are too numerous to list, use this price guide to work out your actual requirements
 8/20, 10/20, 12/20 Tubular tantalum 20p each
 16-32/275V, 100-100/150V, 100-100/275V 30p;
 50-50/385V, 12,000/12V, 32-32-50/300V, 20-20-20/350V 60p; 700 mfd/200V £1.00; 100-100-100-150-150/320V £2.00.

RS 100-0-100 micro amp null indicator
 Approx. 2" x 3/4" x 3/4" £1.50

INDICATORS	
Bulgin D676 red, takes M.E.S. bulb	30p
12 volt or Mains neon, red pushfit	18p
R.S. Scale Print, pressure transfer sheet	10p

CAPACITOR GUIDE - maximum 500V
 Up to .01 ceramic 3p. Up to .01 poly 4p.
 .013 up to .1 poly etc. 5p. .12 up to .68 poly etc. 6p. Silver mica up to 360pF 8p, then to 2,200pF 11p, then to .01 mfd 18p.
 8p. 1/600; 12p. .01/1000, 8/20. 1/900, .22/900, 4/16. .25/250 AC (600VDC) 40p.
 5/150, 10/150, 40/150.

Many others and high voltage in stock.

FORDYCE DELAY UNIT
 240 volt A.C./D.C. Will hold relay, etc., for approx. 15 secs after power off. Ideal for alarm circuits, etc. £1

CONNECTOR STRIP
 Belling Lee L1469, 4 way polythene. 8p each
 1 1/2 glass fuses 250 m/a or 3 amp (box of 12) 6p
 Bulgin, 5mm Jack plug and switched socket (pair) 30p
 Reed Switch 28mm. body length 5p

Aluminium circuit tape, 1/8" x 36 yards—self adhesive. For window alarms, circuits, etc. 60p

MAINS DROPPERS	
66+66-158 ohm, 66-66+137 ohm	
17+14-6 ohm, 266+14+193 ohm	5p
285+575+148+35 ohm	
25+35+97+59+30 ohm	5p

5 1/2" x 2 3/4" Speaker, ex-equipment 3 ohm 30p
 2 Amp Suppression Choke 8p
 3 x 2 1/2 x 1 1/2" PAXOLINE 4p
 4 3/8 x 1 1/2 x 1 1/2" } 1p
 PCV or metal clip on MES bulb Holder 4p
 VALVE RETAINER CLIP, adjustable 2p

OUTPUT TRANSFORMERS
 Sub-miniature Transistor Type 25p
 Valve type, 40p

GCM21T/22T/24T Stylii 15p
 Whiteley Stentorian 3 ohm constant impedance volume control way below trade at 80p
 RS Yellow Wander Plug Box of 12 25p
 18 SWG multicore solder 2 1/2p foot

THE RADIO SHACK
 161 ST. JOHNS HILL, BATTERSEA, LONDON S.W.11
 Open 10 a.m. till 7 p.m. Tuesday to Saturday. VAT receipts on request.
 Terms: Payment with order Telephone: 01-223 5016

SEMICONDUCTORS

Full spec. marked by Mullard, etc. Many other types in stock

AC128/1/6	8p	BCX32 36	12p	8FW10/11 F.E.T.	40p
ACY29	19p	BCY40	50p	8FW30	£1
AD149	40p	BCY70/1/2	12p	8FW57/58	17p
AF116	16p	BD113	50p	8FX12/29/30	20p
AF124/6/7	26p	BD115/6	31p	8FX84/88/89	17p
AF139	20p	BD131/2/3	35p	8FY50/51/52	13p
AF178/80/81	30p	BD135/6/7/9	30p	BFY90	50p
AF239	30p	BD140/142	30p	BR101	30p
ASV27/73	30p	BD201/2/3/4	£0p	BR39/56	26p
BC107/8/9 + A/B/C	6p	BD232/4/5/8	49p	BSV64	30p
BC147/8/9 + A/B/C/S	6p	BDX77	£1	BSV79/80 F.E.T.s	80p
BC157/8/9 + A/B/C	6p	BD437	50p	BSV81 Mosfet	90p
BC178A/B, 179B	12p	BF115/167/173	15p	BSX20/21	14p
BC184C/LC	9p	BF178/9	20p	BSY40	27p
BC186/7	20p	BF180/1/2/3/4/5	15p	BSY95A	12p
BC213/L214B	10p	BF194/5/6/7	6p	CV7042 (OC41/44 ASY63)	5p
BC261B	8p	BF194A, 195C	6p	GET111	40p
BC277/8, 337/8	8p	BF200, 258, 324	20p	ON222	20p
BC547/8/8A/8C	10p	BF202/3	30p	TIS88A F.E.T.	23p
		BF336	27p	ZTX300/341	7p
		BFS28 Dual Mosfet	£1	2N393 (MA393)	30p
				2N456A	50p
				2N929	14p
				2N987	40p
				2N1507/2219	15p

BRIDGE RECTIFIERS

Amp	Volt		
1	1,600	BYX10	30p
1	140	OSHO1-200	26p
1.4	42	BY164	40p
0.6	110	EC433	6p
5	400	Texas	90p

RECTIFIERS

Amp	Volt		
IN4004/5/6	1	4/6/800	5p
IN4007/BYX94	1	1,250	5p
BY103	1	1,500	18p
SR100	1.5	100	7p
SR400	1.5	400	8p
REC53A	1.5	1,250	14p
LT102	2	30	10p
BYX38-300R	2.5	300	40p
BYX38-600	2.5	600	45p
BYX38-900	2.5	900	50p
BYX38-1200	2.5	1,200	55p
BYX48-300R	2.5	300	26p
BYX49-600	3	600	35p
BYX49-900	3	900	40p
BYX49-1200	3	1,200	52p
BYX48-300R	6	300	40p
BYX48-600	6	600	50p
BYX48-900	6	900	60p
BYX48-1200R	6	1,200	80p
BYX72-150R	10	150	35p
BYX72-300R	10	300	45p
BYX72-500R	10	500	55p
BYX42-300	10	300	30p
BYX42-600	10	600	65p
BYX42-900	10	900	80p
BYX42-1200	10	1,200	95p
BYX46-300R*	15	300	£1.00
BYX46-400R*	15	400	£1.50
BYX46-500R*	15	500	£1.75
BYX46-600*	15	600	£2.00
BYX20-200	25	200	60p
BYX52 300	40	300	£1.75
BYX52-1200	40	1,200	£2.50

*Avalanche type

TRIACS

Amp	Volt		
6	800	Plastic RCA	£1.20
25	900	BTX94-900	£4.00
25	1200	BTX94-1200	£6.00

RS 2mm Terminals
Blue & Black 5 for 40p

Chrome Car Radio fascia 15p
Rubber Car Radio gasket 5p
DLI Pal Delayline 50p

Relay socket 10p
Take miniature 2PCO relay

B9A valve can 5p

0-30, or 0-15, black pvc, 360° dial, silver digits, self adhesive, 4 1/2" dia. 10p

OPTO ELECTRONICS

Diodes	Photo transistor
TIL209 Red 12p	BPX29 80p
BPX40 50p	OCP71 34p
BPX42 80p	
BPY10 80p	
(VOLIAC).	
BPY68 } 80p	BIG L.E.D. 0.2"
BPY69 } 2v 50m/A max.	ORANGE 14p
BPY77 } 80p	YELLOW 14p
	RED 14p

PHOTO SILICON CONTROLLED SWITCH BPX66 PNP 10 amp £1.00

3" red 7 segment L.E.D. 14 D.I.L. 0-9+D.P. display 1.9v 10m/a segment, common anode 61p

Minitron 3" 3015F filament £1.10

CQY11B L.E.D.
Infra red transmitter £1
One fifth of trade

Plastic, Transistor or Diode Holder 1p
Transistor or Diode Pad 1p
Holders or pads 50per100

Philips Iron Thermostat 15p
MoMurdo PP108 8 way edge plug 10p

T03 HEATSINK
Europlec HP1 T03B individual 'curly' power transistor type. Ready drilled 12p

Tested unmarked, or marked ample lead ex new equipment

ACY17-20 8p	OC200-5 8p
AS220 8p	TIC44 24p
ASZ21 30p	2G240 £1
BC186 11p	2G302 5p
BCY30-34 8p	2G401 5p
BCY70/1/2 8p	2N711 25p
BY126/7 4p	2N2926 4p
HG1005 10p	2N598/9 6p
HG5009 3p	2N1091 8p
HG5079 3p	2N1302 8p
L78/9 3p	2N1907 £1
M3 10p	Germ. diode 1p
OA81 3p	GET120 (AC128 in 1" sq. heat sink 15p
OA47 3p	GET872 12p
OA200-2 3p	2S3230 30p
OC23 20p	

2N2401	30p
2N2412	70p
2N2483	23p
2N2904/5/6/7/7A	15p
2N3053	14p
2N3055 R.C.A.	50p
2N3704	8p
2N3133	20p
2N4037	34p
2N5036 (Plastic 2N3055)	30p
2SA141/2/3/60	31p
2SB135/6/457	20p
40250 (2N3054)	30p

NEW B.V.A. VALVES

EB91	34p
ECL80	34p
PCC84	34p

TRANSFORMER
Ferromag C core. Screen-95-105-115-125-200-220-240v input; output 17v 1A x 2 + 24-0-24v 1.04A + 20v 1mA. These current ratings can be faithfully exceeded by 50%.
£3.50 + £1.00 p&p.

WOODS 240V A.C.
Approx. 2.500 r.p.m. continuous rated 5 or 6in. FAN (ex-computer)
£3.60 plus £1 p&p

OTHER DIODES

1N916	6p
1N4148	2p
BA145	14p
Centercel	24p
BZY61/BA148	10p
BB103/110 Varicap	15p
BB113 Triple Varicap	37p
BA182	13p
OA5/7/10	15p
BZY88 Up to 33 volt	7p
BZX61 11 volt	15p
BR100 Diac.	15p

INTEGRATED CIRCUITS

TAA700	£2.00
TBA800	£1.00
741 8 pin d.i.l. op.	24p
SN76013N	£1.20
TAD100 AMRF	£1
CA3001 R.F. Amp	50p
CD4013 CMOS	36p
TAA300 1wt Amp	£1
TAA550 Y or G	22p
TAA263 Amp	65p
7400	10p
7402/4/10/20/30	14p
7414	56p
7438/74/86	24p
7483	69p
LM300, 2-20 volt	£1
74154	90p
TBA550Q	£1.50

THRISTORS

Amp	Volt		
1	240	BTX18-200	30p
1	400	BTX18-300	35p
1	240	BTX30-200	30p
15	500	BT107	£1
6.5	500	BT101-500R	90p
6.5	500	BT109-500R	£1.00
20	600	BTW92-600RM	£3.00
15	800	BTX95-800R Pulse Modulated	£8.00
30	1000	28T10 (Less Nut)	£3.00

PAPER BLOCK CONDENSER

0.25MFD	800 volt	30p
1MFD	250 volt	15p
2MFD	250 volt	20p
4MFD	250 volt	20p

I.C. extraction and insertion tool 32p

CHASSIS SOCKETS
Car Aerial 9p, Coax 3p, 5 pin 180° 9p, 5 or 6 pin 240° din 6p, speaker din switched 5p, 3.5 mm switched 5p, stereo 1/4" jack enclosed 10p.

CRAZY OFFERS

2200 mfd.	64v	40p
2500 mfd.	40v	30p
8 mfd.	500v	6p
400 mfd.	16v	4p
.1 mfd.	500v	1 1/2p
.1 mfd.	1500v	2p
2200 mfd.	25v	30p
1000 mfd.	200v	25p
10000 mfd.	15v	12p
1250 mfd.	35v	10p
6800 mfd.	10v	6p
32+32 mfd.	275v	8p
16+32 mfd.	350v	12p
8+8 mfd.	350v	8p
150 mfd.	35v	4 1/2p
100 mfd.	70v	4 1/2p
1 mfd. non-polar	350v	3p
680 mfd.	100v	10p
15 mfd.	160v	3p
4700 pf. sub min	500v	1 1/2p
4700 mfd.	63v	70p
300 mfd.	450v	25p

Philips electronic engineer kits add on series E1004, 75p each

G.E.C. 5% Hi-stab capacitors .013, .056, .061, .066, .069, .075, .08, .089 2p each

Push-to-Break or Push-to-Make Panel Switch 24p

ENAM. COPPER WIRE
SWG. PER YD.
24 3p
26 to 42 2.5p

GARRARD
GCS23T Crystal Stereo Cartridge 66p
Mono (Stereo compatible), Ceramic or crystal 60p

HANDLES
Rigid light blue nylon 6 1/2" with secret fitting screws 5p

Belling Lee white plastic surface coax outlet box 20p

Miniature Axial Lead Ferrite Choke formers 2p

RS 10 Turn Pot 1%
250, 500 Ω, 1K, 50K £1

Copper coated board 10" x 9" approx 25p

TIE CLIPS
Nylon self locking 3 1/2" 2p

Geared Knob 8-1' ratio 1 7/8" diam, black 70p

R.S. 2 1/2" 35. ohm loud speaker 60p

SMALL ORDERS, ENCLOSE SUITABLE STAMPED ADDRESSED ENVELOPE
LARGE ORDERS, ADD SUFFICIENT FOR POSTAGE, PACKING, INSURANCE, ETC.
TOTAL GOODS PLUS CARRIAGE, ADD V.A.T.

MAIL ORDER CUSTOMERS ONLY ADD 8% VAT-I PAY BALANCE ON 12 1/2% ITEMS ALL ENQUIRIES, ETC., MUST BE ACCOMPANIED BY A STAMPED ADDRESSED ENVELOPE

DIRECT SUPPLY SERVICE TO READERS . . .

TOWERS INTERNATIONAL TRANSISTOR SELECTOR

(NEW REVISED EDITION)

This is dead!

If it takes you longer than 1 minute to find out all about these transistors then you need a copy of TOWER'S INTERNATIONAL TRANSISTOR SELECTOR. Its one of the most useful working books you will be offered this year. And probably the cheapest!

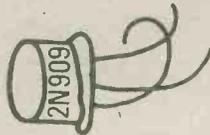

Japanese. And we think that they will solve 90% of your transistor enquiries.

Current and widely used obsolete types were carefully selected and arranged in Numero-Alphabetical order by an author who was uniquely qualified to do the job. With his compendium, all you need to know is the type number

Would this replace it?



In it you will find a really international selection of 10,000 transistor types - British, Continental European, American and

and you can learn all about a transistor's specification; who made it and where to contact them; or what to use to replace it.

Look at the entry for 2N909

TRANSISTOR NUMBER	PM DA LT	PACK- AGE	LEAD INFO	V _{CB} MAX	V _{CE} MAX	V _{EB} MAX	I _C MAX	T _J MAX	P TOT	F T	C B MIN MAX	H FE	H FE BIAS	USE	MFR	EURO EQVT	USA EQVT	ISS
2N909	NS	TO18	LO1	60V	30V	5V	200MA	175C	500MWF	50M	25P	110MN	50MA	AMG	SGI	BSX 33	2N731	0

This is what you will learn from it

TYPE NO	POL & MAT	LEAD INFO	V _{CB} MAX	V _{CE} MAX	V _{EB} MAX	I _C MAX	T _J MAX	P TOT	F T	C B MIN MAX	H FE	H FE BIAS	USE	MFR	EURO EQVT	USA EQVT	ISS	
(EXAMPLE) 2N909	NS	TO18	LO1	60V	30V	5V	200	175C	500MWF	50M	25P	110 MN	50 MA	AMG	SGI	BSX 33	2N 731	0

NUMERO ALPHABETIC LISTING
 N - NPN
 P - PNP
 G - GERMANIUM
 S - SILICON

REFER TO CASE OUTLINES APPENDIX C

REFER TO LEAD DETAILS - APPENDIX B

MAXIMUM PERMISSIBLE COLLECTOR - BASE VOLTAGE WITH EMITTER OPEN CIRCUIT

MAXIMUM PERMISSIBLE COLLECTOR - EMITTER VOLTAGE WITH BASE OPEN - CIRCUIT

MAXIMUM PERMISSIBLE EMITTER - BASE VOLTAGE WITH COLLECTOR OPEN CIRCUIT

MAXIMUM PERMISSIBLE COLLECTOR CURRENT

MAXIMUM PERMISSIBLE JUNCTION TEMPERATURE

MAXIMUM PERMISSIBLE DEVICE DISSIPATION - F IN FREE AIR AT 25°C C - WITH CASE SURFACE HELO AT 25°C H - IN FREE AIR AT 25°C WITH METAL HEAT SINK ATTACHED TO DEVICE

MINIMUM FREQUENCY CUT OFF F_c INDICATED IN K - KILOHERTZ M - MEGAHERTZ G - GIGAHERTZ

F_c - FREQUENCY AT WHICH COMMON-EMITTER CURRENT GAIN DROPS TO UNITY TYPICAL F_c CAN BE TAKEN AS ROUGHLY TWICE F_c MIN

SUGGESTED EIA - JEDEC 2N STANDARD POSSIBLE SUBSTITUTE

SUGGESTED PROELECTRON STANDARD POSSIBLE SUBSTITUTE

CODE INDICATION POSSIBLE SUPPLIER OF DEVICE - SEE SUPPLIER - APPENDIX F

CODE INDICATION OF APPLICATION USAGE - SEE APPENDIX A

BIAS CURRENT AT WHICH CURRENT GAIN H_{FE} IS CHARACTERISED

CURRENT GAIN NORMALLY DC (BUT SOMETIMES RELATED A.C. GAIN) AT I_C BIAS SPECIFIED - WHERE MIN (MIN) ONLY IS SPECIFIED TYPICAL (TP) CAN BE TAKEN AS TWICE MIN AND VICEVERSA

MAXIMUM COLLECTOR CAPACITANCE TYPICAL USUALLY 1 TO 3 MAXI - NORMALLY EMITTER OPEN - CIRCUIT AND INDICATED BY P - PICOFARAD OR N - NANOFARAD - FOR HF DEVICES C_{cb} IS GIVEN AND PICOFARADS THEN INDICATED BY R INSTEAD OF P

*ISS COLUMN INDICATES ISSUE NO OF DATA LINE ENTRY

Tower's International Transistor Selector

by **T. D. TOWERS**
 MBE, MA, BSc, C Eng, MIERE

£5.00

inc. post and packing

To:—DATA PUBLICATIONS LTD.
 57 MAIDA VALE
 LONDON W9 1SN

Please send me copy/copies
 to the address shown below

NAME

ADDRESS

(Block capitals)

THE MODERN BOOK CO

THE RADIO AMATEUR'S HANDBOOK 1977

by A.R.R.L. Price: £6.50

BASIC ELECTRONICS Vol. 1-V
by Schools Council

£7.50 set

ADVANCED APPLICATIONS FOR POCKET CALCULATORS

by J. Gilbert

PRICE: £4.00

BUILD-IT BOOK OF MINIATURE TEST & MEASUREMENT INSTRUMENTS

by R. P. Haviland

PRICE: £3.45

OP-AMP CIRCUIT DESIGN & APPLICATIONS

by J. Carr

PRICE: £4.00

UNDERSTANDING MICROPROCESSORS

by Motorola

PRICE: £3.75

MICROPROCESSOR/MICROPROGRAMMING HANDBOOK

by B. Ward

PRICE: £4.00

WORLD RADIO TV HANDBOOK

by J. M. Frost

PRICE: £5.50

MAKING YOUR OWN ELECTRONIC GADGETS A BEGINNER'S GUIDE

by R. H. Warring

PRICE: £2.90

THE CATHODE RAY OSCILLOSCOPE & ITS USE

by G. N. Patchett

PRICE: £4.00

BUILD YOUR OWN WORKING ROBOT

by D. L. Heiserman

PRICE: £3.60

28 TESTED TRANSISTOR PROJECTS

by R. Torrens

PRICE: £1.20

50 PROJECTS USING IC CA3130

by R. A. Penfold

PRICE: £1.20

50 PROJECTS USING RELAYS SCR'S & TRIACS

by F. G. Rayer

PRICE: £1.30

SIMPLE ELECTRONICS FOR MODELLERS

by I. R. Sinclair

PRICE: £3.20

ELECTRONICS FAULT DIAGNOSIS

by I. R. Sinclair

PRICE: £3.00

BEGINNER'S GUIDE TO AUDIO

by I. R. Sinclair

£3.00

AUDIO AMPLIFIERS FOR THE HOME

CONSTRUCTOR

by I. R. Sinclair

PRICE: £2.50

RADIO COMMUNICATION HANDBOOK Vol. 1

by R.S.G.B.

PRICE: £9.00

PRICES INCLUDE POSTAGE

We have the Finest Selection of English and American Radio Books in the Country

19-21 PRAED STREET (Dept RC) LONDON W2 1NP

Telephone 01-723 4185

1. Understand electronics.

Step by step, we take you through all the fundamentals of electronics and show you how easily the subject can be mastered using our unique Lerna-Kit course.

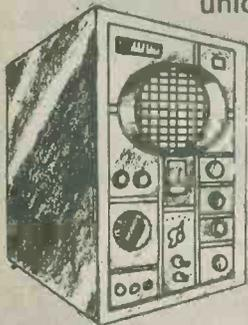

- (1) Build an oscilloscope.
- (2) Read, draw and understand circuit diagrams.
- (3) Carry out over 40 experiments on basic electronic circuits and see how they work.

2. Become a radio amateur.

Learn how to become a radio-amateur in contact with the whole world. We give skilled preparation for the G.P.O. licence.

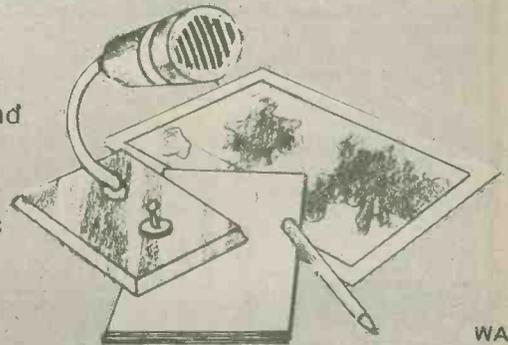

WAA

Free!

Brochure, without obligation to:
BRITISH NATIONAL RADIO & ELECTRONICS SCHOOL,
P.O. Box 156, Jersey, Channel Islands.

NAME _____

ADDRESS _____

Block caps please

REC 77

ambit INTERNATIONAL Trade Mark

The Wireless Specialists for components & modules.

EF5800, 7030 & 91196 - .9uV/30dB S/N., 0.2% THD
Our top three FM tunermodules. (EF5800 shown with can off).

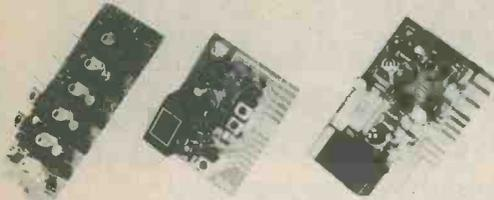

From left to right, the EF5800 6 circuit varicap FM tunerhead with the 7030 linear phase IF and the 91196 PLL stereo decoder with integral 55kHz 'birdy' filter. The system provides afc muting, meter drives, agc, auto stereo switch, & a specification that exceeds broadcast requirements. Now available with a new EF5801 tunerhead, with FET buffered oscillator output for synthesiser/frequency readout facilities.

EF5801...£17.45; EF5800...£14.00; 7030...£10.95; 91196...£12.99

Complete FM tuner kits/systems (Carriage £3 extra.)

The Mark 8 Signalmaster - by Larsholt Electronics

This tuner is based on the popular 7252 tunerset, and provides an incomparable combination of style and performance that can be built by even the relatively inexperienced constructor. Complete kit...£85.00; matching 25+25W amplifier...£79.00.

International Mark 2 Tuner kits:

Complete tuner kit, based around the 7253 tunerset, £65.00. Or just the chassis, cabinet, heavy aluminium front panel - for your own choice of modules- see our new info. leaflet on the International Tuner. (SAE please)

**NEW NEW NEW NEW NEW NEW NEW
BIONIC FERRET METAL LOCATOR**

Ambit has designed a new approach to cost effective sensitive metal locators, and now we proudly present the first of the family of 'Bionic Ferrets'. Details OA, but we can say it will detect a 10p piece at 8-10 inches. Coupled with low power consumption and many innovations, this is the first radically advanced detector that can be made from a kit. £37.99

Radio module selection: (Prices for kits in our catalogue & PL)

EF5800	Ambit 6 stage varicap 88-108MHz tunerhead	£14.00
EF5600	TOKO 5 stage varicap	£12.95
EC3302	TOKO 3 stage varicap	£7.50
7020	Dual ceramic filter FM IF system module	£6.95
92310	MPX decoder, with stereo filter and preamp	£6.95
93090	MPX decoder with CA3090AQ + filter stage	£7.35
91197	MW/LW varicap AM tuner module	£11.35
771	New 'Off-Air' UHF varicap TV sound tunermodule with mute, AFC, dual conversion, PSU	£27.00
9014	MW/LW/Stereo FM tuner chassis. Mech. tuned	£26.00

Components: ICs, coils, filters, trimmers, diode law pots etc.

HA1137W/3089E FM IF	1.94	TOKO AM IF TS:	
TBA120 FM IF and demod.	0.75	455/470kHz types	0.30
MC1350 FM IF preamp	0.97	10.7MHz types	0.33
SN76660N FM IF and det.	0.75	(10mm square, with int. cap.)	
MC1310/4400 PLL MPX	2.20	455kHz Mechanical filters	
CA3090AQ PLL MPX	3.75	4 or 7 kHz bandwidths	1.95
HA1196 PLL MPX	4.20	455kHz ceramic IF filters	
UA720 AM radio system	1.40	6 or 8 kHz bandwidth CFT	0.55
TBA651 AM radio system	1.81	SFD455 (Murata)	0.75
HA1197 AM radio system	1.40	455kHz dual ceramic CFX	1.80
LM1496 balanced mixer	1.25	10.7MHz filters for WBFM:	
11C90 600MHz decade ctr	14.00	3132A 6 pole lin phase	2.25
LM380N 2W Audio	1.00	3125N 4 pole lin phase	1.30
LM381N audio preamp st.	1.81	CFS ceramic filters	0.50
TDA2020 20W audio amp	2.99	Pilot tone (MPX) filters:	
TCA940 10W audio amp	1.80	BLR3107N stereo	1.90
NE723 voltage reg IC	0.80*	BLR2007N	1.95
TDA1412 12v 600mA reg	0.95*	BLR3152/mono	0.97
78M20 20v 500mA	1.20*	BLR3172N tape bias trap, with	
TAA550B varicap regulator	0.50*	85 or 100kHz pole	0.97
NE560/1/2B PLL ICs	3.50*	various chokes etc. see price list	
ICL8038CC function gen	4.50*		

22turn 100k diode law trim pots, with Integral knob 40p
270° rotary 100k diode law tuning pot 32p
Also...meters for tuners, AM tuning varicaps, MOSFETs etc....

post/packing 22p per order - except where indicated

General: All prices shown here exclude VAT, which is generally 12½%. (Except where marked*). The latest price leaflet is available FOC with an SAE. Please send a (large) SAE with any enquiries. Full catalogue still 40p.

37 High Street, Brentwood, Essex. CM14 4RH.
TELEPHONE (0277) 216029 - after 3pm if possible please.

NEW STYLE SELF-BINDER

for "Radio & Electronics Constructor"

The "CORDEX" Patent Self-Binding Case will keep your issues in mint condition. Copies can be inserted or removed with the greatest of ease. Rich maroon finish, gold lettering on spine.

Specially constructed Binding Cords are made from Super Linen of great strength, very hard twisted and twice doubled. They are attached to strong RUSTLESS Springs under tension, and the method adopted ensures PERMANENT RESILIENCE of the Cords. Any slack that may develop is immediately compensated for and the Cords will always remain taut and strong. It is impossible to overstretch the springs, as a safety check device is fitted to each.

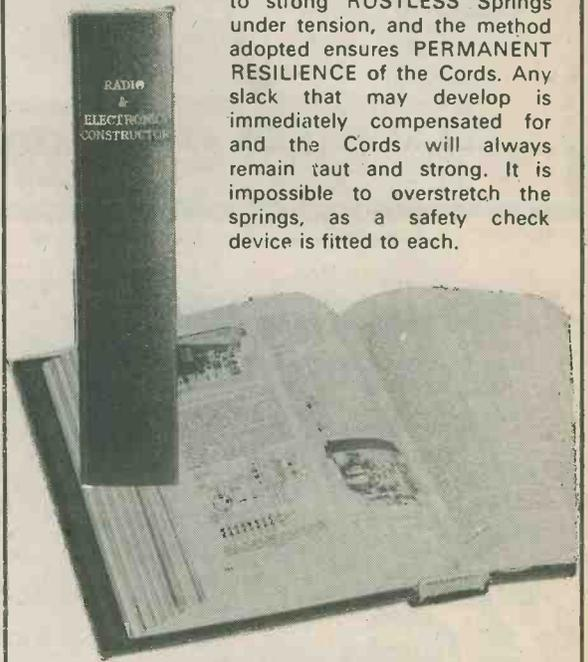

PRICE **£1.20** P.&P. 30p

including V.A.T.

Owing to heavy demand please allow 21 days for delivery

Available only from:—

Data Publications Ltd.
57 Maida Vale London W9 ISN

**FANTASTIC
GOLDRING
SAVINGS**

**GOLDRING G103
Belt Drive Turntable**

Famous name turntable slashed to near half price. Complete with plinth, cover and leads. Accepts any standard cartridge (not included)
FULL 12 MONTH GUARANTEE



**OUR PRICE
£29.95**

R.R.P. £54 (+p/p & Ins £2.25)

SAVE
OVER £24

**Build your own
GOLDRING CK2
Belt Drive Turntable**

Beautifully engineered unit from the famous Goldring company, comes complete with instructions and all necessary parts. Ready to incorporate into your design plinth and cover. The pleasure of assembling your own deck.

(Plinth, cover and cartridge not included).
Usually sold for £54.95 with plinth and cover.

Call in or send cheque, P.O., M.O., Access, Barclaycard, Diners Club or American Express Number.



**ONLY
£16.95**

(+ p.p. & Ins. £1.50)

ALL PRICES
INC. VAT

Sonic Sound Audio

248/250 TOTTENHAM COURT ROAD, LONDON W1. TEL: 01-637 1908



**Wilmslow
Audio**

THE firm for speakers!

SEND 10P FOR THE WORLDS BEST CATALOGUE OF SPEAKERS, DRIVE UNITS KITS, CROSSOVERS ETC. AND DISCOUNT PRICE LIST

ACT ● AUDAX ● BAKER ● BOWERS & WILKINS ● CASTLE ● CELESTION ● CHARTWELL ● COLES ● DALESFORD ● DECCA ● EMI ● EAGLE ● ELAC ● FANE ● GAUS ● GOODMANS ● HELME ● I.M.F. ● ISOPHON ● JR ● JORDAN WATTS ● KEF ● LEAK ● LOWTHER ● MCKENZIE ● MONITOR AUDIO ● PEERLESS ● RADFORD ● RAM ● RICHARD ALLAN ● SEAS ● TANNY ● VIDEOTONE ● WHARFEDALE

WILMSLOW AUDIO DEPT REC

SWAN WORKS, BANK SQUARE, WILMSLOW
CHESHIRE SK9 1HF

Discount HiFi Etc. at 5 Swan Street and 10 Swan Street
Tel: Wilmslow 29599 for Speakers Wilmslow 26213 for HiFi

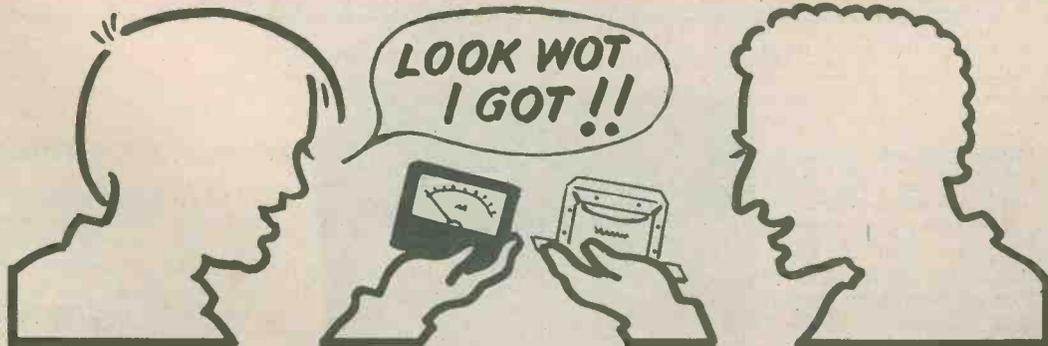

Please write your Name and Address in block capitals

NAME

ADDRESS



**POST
THIS
COUPON**
with cheque
or p.o. for
£1.40

HOME RADIO (Components) LTD., Dept. RC
234-240 London Road, Mitcham, Surrey CR4 3HD

Regd No 912966 London

I bought this beautiful little milliamp-meter through the special Bargain List that Home Radio sent me when I bought a copy of their famous Components Catalogue. I reckon I saved a good £1.50 on this one item alone — more than the catalogue itself cost. If I'm not mistaken, you got that natty transformer the same way, so no doubt you're as familiar as I am with the scores of bargains they're offering.

But have you noticed that there are quite a few bargains in the main catalogue itself? That Resistor Pack SP22 for instance — 400 preferred value 1/4 watt 5% resistors for only £6, beautifully arranged for easy selection. If that's not a bargain, what is? For those readers who have not yet caught on to the advantages of dealing with Home Radio let us explain. Purchase a Home Radio catalogue, £1.40 including postage and packing, or £1 over the counter. It has over 200 pages, listing about 5,000 items, nearly 2,000 of them illustrated. With every catalogue Home Radio give you free an up-to-date Bargain List. Why wait? Send the coupon with a cheque or P.O. for £1.40 to Home Radio Components, 240 London Road, Mitcham, Surrey.

HOME RADIO (Components) LTD. Dept. RC, 234-240 London Road, Mitcham, CR4 3HD. Phone: 01-648 8422

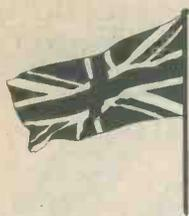

The

'JUBILEE'



A.M. — F.M. RECEIVER

Part 1

By Sir Douglas Hall, K.C.M.G.

Incorporating two reflex circuits and permeability tuning on a.m., this 3-band receiver covers long waves, medium waves and the v.h.f. f.m. band. An ingenious circuit design enables all waveband and on-off switching to be carried out with a 3-pole 4-way rotary switch. The circuit is introduced and construction starts in this month's article.



This receiver covers the whole of the medium and long wave bands, and a large part of Band 2 which is used by v.h.f. broadcast stations in the United Kingdom. It can be set up to cover a different part of this band if necessary.

Dealing first with the tuner section, the circuit arrangements have often been used by the author in the past, and are based on his very reliable Spontaflex circuit, using the Super Alpha version for a.m. and the D.R.C. (double reflex Colpitts) system for f.m. It

is stressed that only a 3-pole 4-way rotary switch is required to effect the considerable circuit changes required for band changing and to provide an on-off function.

Three transistors are employed in the tuner section, and only two of these are in use at any time. Although TR1 doubles up on a.m. and f.m., TR3 is used only on a.m. and TR2 only on f.m. A telescopic aerial picks up the v.h.f. stations. A ferrite rod assembly is in use on the other bands.

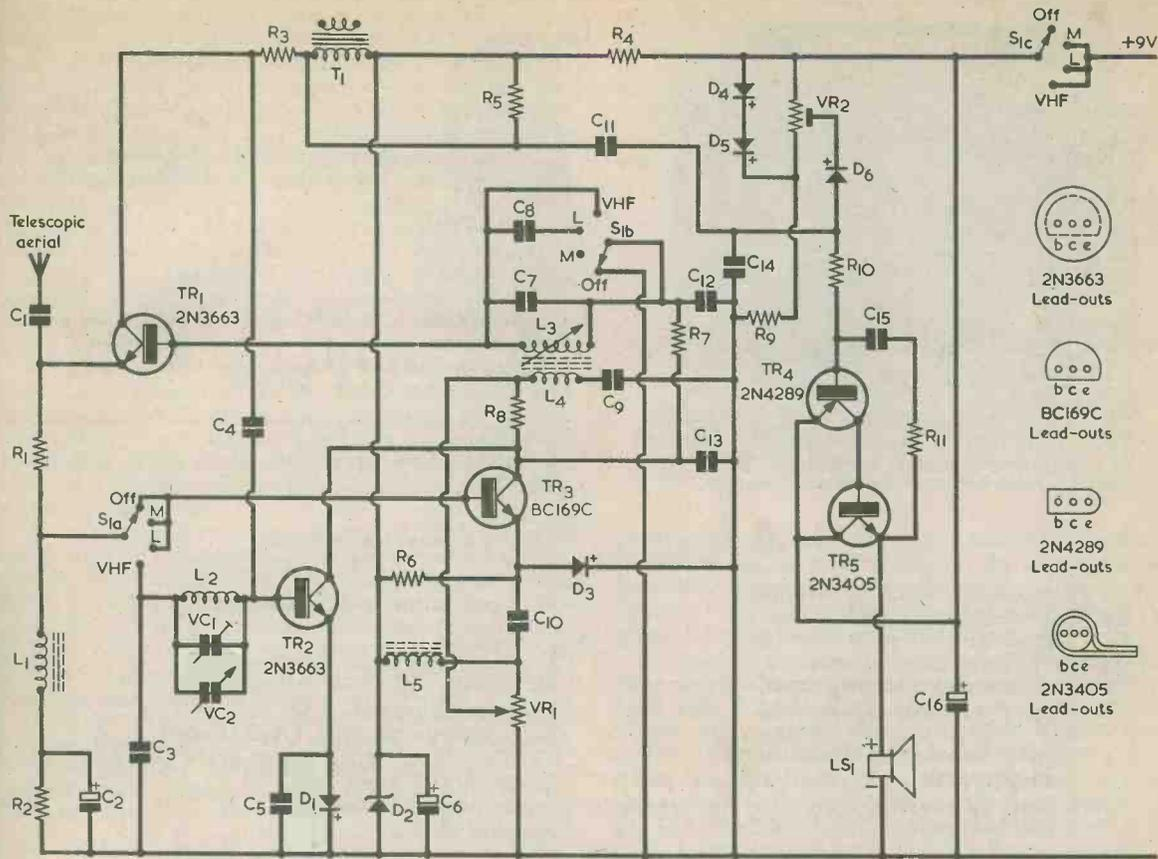

Fig. 1. The circuit of the a.m.-f.m. receiver

CIRCUIT FUNCTIONING

The circuit appears in Fig. 1, in which the switch is shown in the "Off" position. Let us suppose it is set to "Medium Waves". The signal is picked up by L3 with C7 in parallel, tuning being accomplished by movement of the ferrite rod within the coil. The signal is applied to TR1 base, and then proceeds from TR1 emitter to the base of TR3. The output is now across D3 and, in fact, TR1 and TR3 have acted as a Super Alpha pair. As a result, although the impedance of the circuit at TR1 base is extremely high, the output impedance at the emitter of TR3 is very low. Indeed, the output impedance at D3 is so low that a special diode is needed for best results, and the impedance of the diode is further reduced by current passing through it via R6 and through TR3. An interfering signal, to which L3 and C7 are not resonant, is presented with a relatively low impedance in the tuned circuit and suffers a nearly complete short-circuit by the time it reaches the output of the Super Alpha pair. Hence the high selectivity of this circuit, which is far better than can be obtained with conventional single tuned arrangements, whether these employ discrete components or an integrated circuit.

We have left the signal, still at radio frequency, across D3. This diode detects the signal, whereupon TR3 acts as a common base audio amplifier with its

output across R8. Thence, the a.f. signal is coupled back to TR1 base via R7 and L3, with TR1 acting now as a common emitter audio amplifier. TR1 has a high amplification factor and this, combined with a low collector current and a little negative feedback because of R1, results in a high input impedance so that R8 is not unduly shunted. An audio output appears across the large winding of a microphone transformer, T1, with R5 in parallel to equalise amplification through the a.f. spectrum and to prevent the possibility of spurious oscillation.

When S1 is moved to "Long Waves", C8 is connected across L3 and C7 to provide the requisite lower frequency tuning range.

The reaction feedback path on medium and long waves is from the emitter of TR3 to L4, which is coupled to L3, and control is given by VR1. As the slider of VR1 approaches the upper end of its track, as shown in Fig. 1, series resistance is lowered and feedback increases. But VR1 is also a potentiometer across the supply and controls the collector current for TR3. So there is a dual control of reaction, with both modes being controlled simultaneously by VR1, and with the second mode acting as a true volume control since there can be no collector current available for TR3 when the potentiometer slider is at the lower end of the track.

A direct current flows through VR1 and a careful

COMPONENTS

Resistors

(All fixed values $\frac{1}{4}$ watt 10%)

- R1 180 Ω
- R2 3.9k Ω
- R3 1k Ω
- R4 1k Ω
- R5 68k Ω
- R6 27k Ω
- R7 15k Ω
- R8 39k Ω
- R9 2.7k Ω
- R10 33k Ω
- R11 330k Ω
- VR1 10k Ω potentiometer, linear (see text)
- VR2 1k Ω pre-set potentiometer, standard or miniature skeleton, horizontal

Capacitors

- C1 10pF silvered mica or ceramic
- C2 64 μ F electrolytic, 10 V. Wkg.
- C3 1,000pF silvered mica or ceramic
- C4 1pF silvered mica or ceramic
- C5 4.7pF silvered mica or ceramic
- C6 125 μ F electrolytic, 10 V. Wkg.
- C7 39pF silvered mica or ceramic
- C8 500pF silvered mica or ceramic
- C9 0.1 μ F polyester
- C10 0.01 μ F polyester
- C11 0.1 μ F polyester
- C12 1,000pF silvered mica or ceramic
- C13 1,000pF silvered mica or ceramic
- C14 1,000pF silvered mica or ceramic
- C15 0.1 μ F polyester
- C16 1,000 μ F electrolytic, 10V. Wkg.
- VC1 12pF ceramic tube trimmer (see text)
- VC2 10pF variable, type C804 (Jackson)

Inductors

- L1 2.5mH r.f. choke type CH1 (Repanco)
- L2 see text
- L3 see text
- L4 see text
- L5 2.5mH r.f. choke type CH1 (Repanco)
- T1 microphone transformer type TT53 (Repanco)

Semiconductors

- TR1 2N3663
- TR2 2N3663
- TR3 BC169C
- TR4 2N4289
- TR5 2N3405
- D1 0A81, 0A90 or 0A91
- D2 6.8V zener diode, 400mW
- D3 0A10
- D4 1S44
- D5 1S44
- D6 1S44

Speaker

- LS1 15 Ω , 6 x 4in (see text)

Switch

- S1 3-pole 4-way rotary (see text)

Miscellaneous

- 18-way group panel (see text)
- 9V battery type PP9 or equivalent
- Battery connectors
- Telescopic aerial type TA10 (Eagle)
- Ferrite rod, 4 x $\frac{3}{8}$ in., orange grade (see text)
- Large control knob
- 2 small control knobs
- Speaker gauze
- Epicyclic drive with flange, Jackson 4511/F
- 1 $\frac{1}{4}$ in. drive drum, Jackson 4597
- Pulley wheel (Home Radio)
- Spring clip, $\frac{3}{8}$ in., Lektrokit (Home Radio)
- Bracket, Lektrokit (Home Radio)
- Nylon drive cord
- Materials for case and chassis



A view inside the case from the back. The telescopic aerial bracket protrudes through a rectangular opening at the case rear

choice of potentiometer is required here if it is not to become noisy with use. The author obtained very good results with a P20 potentiometer as supplied by Electrovalue. An even longer life should be given by a 1 watt wire-wound potentiometer. If the wirewound potentiometer is employed it requires a shaft extension.

V.H.F. RECEPTION

It will be seen that, with the circuit as so far described, TR2 has had its base bias circuit disconnected. As it is a silicon transistor this is the equivalent of removing it and its associated components from circuit. But by turning S1 to "V.H.F.", TR2 becomes active and TR3 ceases to function.

The v.h.f. signal is picked up by the telescopic aerial and passed through the isolating capacitor C1 to the emitter of TR1, which amplifies as a common base amplifier. The amplified signal at its collector is fed via C4 to the base of TR2, and the tuned circuit given by L2, VC1 and VC2 comes into use. TR2 now acts as a Spontaflex amplifier, as did TR3 on medium and long waves, functioning as a common collector

radio frequency amplifier and a common base audio amplifier. D1 is a diode suitable for v.h.f. operation and it detects the signal. Oscillation is in the Colpitts mode, with C5 providing a capacitive tap into the tuned circuit. Control is given, with VR1, by variation of current through TR2 only, no variation in coupling taking place as occurs with TR3 when a.m. signals are being received. Because f.m. signals are involved the synchronous method of demodulation is used, TR2 oscillating gently while receiving the signal. The audio output appears across R8, as it did when receiving a.m. signals, and the functioning of the circuit thereafter is identical. Note that the tuned circuit for a.m. is now short-circuited. If this is not done there may be instability.

Mechanical arrangements in the receiver ensure that the movement of the ferrite rod within L3 and the turning of VC2 are carried out simultaneously by one control. It will also be found that the whole of the 180 degree sweep is required to cover the useful part of Band 2, thereby ensuring that tuning is reasonably simple to carry out.

The a.f. amplifier section consists of TR4, TR5 and the associated components, and they provide a simple "sliding bias" arrangement. A small part of the audio signal is rectified by D6 and this sets the bias at the base of TR4 in accordance with signal amplitude. Also, as TR4 is directly coupled to TR5, the base bias for TR5 is set as well. D4 and D5 help to keep the standing bias steady as battery voltage falls. R10 and C14 filter out any residual signal frequencies which may be present, and R11 and C15 provide a degree of negative feedback. C15 must be a good quality component with no leakage current. The current drawn by TR4 and TR5 is proportional to incoming signal level, as with a Class B amplifier, although Class A is used here. An output of about 500mW is possible, at which sound peaks may cause 150mA or more to pass momentarily. The average current at normal volume levels will be much lower, at some 25 to 35mA. A speaker with an impedance of less than 15 Ω must not be used.

It is important to observe the polarity of the speaker tags, as shown by the plus and minus signs in Figs. 1 and 4. This polarity corresponds with the cone of the speaker moving outwards and can be determined by momentarily applying a 1.5 volt cell across the speaker. When this results in an outward movement of the cone the speaker polarity may be assumed to be the same as that of the cell. With some speakers the tag indicated as "plus" in the diagrams may actually have a red marking.

COMPONENTS

Some notes on component availability are necessary before proceeding to constructional details.

The ferrite rod used for L3 should be orange grade, and it is available from Amatronix, 396 Selsdon Road, South Croydon, Surrey, CR2 0DE. Other grades of rod could be used but they may necessitate an alteration in the number of turns in L3 for correct medium wave coverage. The transistor type 2N3663 is listed by Electrovalue, Limited, 28 St. Judes Road, Englefield Green, Egham, Surrey, TW20 0HB. (The BF167, with no connection made to its shield, could be used as an alternative, but with some loss in sensitivity and a slight increase in noise).

It is advisable to obtain the speaker before starting

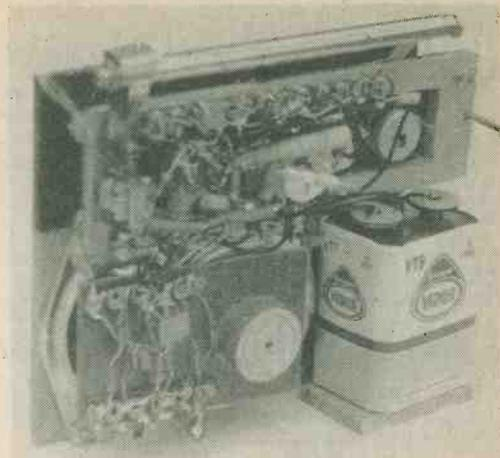

The receiver assembly removed from its case

constructional work in case any small discrepancies in dimensions, as compared with the model used by the author, necessitate corresponding changes in panels or the case. Dimensions can be checked against the actual speaker before cutting out, etc.

S1(a)(b)(c) is a miniature rotary switch with a body diameter of 28mm. The telescopic aerial is an Eagle type TA10, which has an extended length of 120cm. and a closed length of 15cm. There are a number of miscellaneous items of hardware, all of which are available from Home Radio, who can also supply the microphone transformer needed for T1. (An alternative to the transformer listed is the Eagle LT44, the primary of this being connected into the circuit. However, the use of this transformer will cause some loss of bass.)

It may be found desirable to amend the values of R6, C7 and C8 after the receiver has been completed and this point is discussed later. VC1 is a tubular Mullard ceramic trimmer.

A number of tagstrips are employed in the receiver. These are cut out from a "Standard" 18-way group panel available from Doram Electronics.

CONSTRUCTION

Commence construction by cutting a piece of $\frac{1}{4}$ in. plywood to the dimensions shown in Fig. 2(a), and cutting out and drilling a piece of $\frac{1}{16}$ in. s.r.b.p. sheet as in Fig 2(b). Hole B is not drilled at this stage. Place the s.r.b.p. piece on top of the wooden piece and screw them together with two small woodscrews, one at each end. Drill out holes A and C in the plywood, using the existing holes in the s.r.b.p. panel as a guide.

The coils are next made up, starting with L3 and L4. Take a piece of Fablon measuring $3\frac{1}{2}$ by $3\frac{1}{2}$ in., cut off a strip of backing paper $\frac{1}{4}$ in. wide from one edge, and roll it round the ferrite rod to form a tube with the exposed section being rolled on last. The adhesive at this section secures to the layer underneath and holds the tube firm. The tube should be made such that the ferrite rod can slide easily in and out of it without any wobble. Leave the rod inside the tube and, starting $\frac{1}{4}$ in. from one end, wind on 15 turns of 34 s.w.g. enamelled wire in a single layer with each turn touching the next. Leave $\frac{1}{4}$ in. and, winding in the

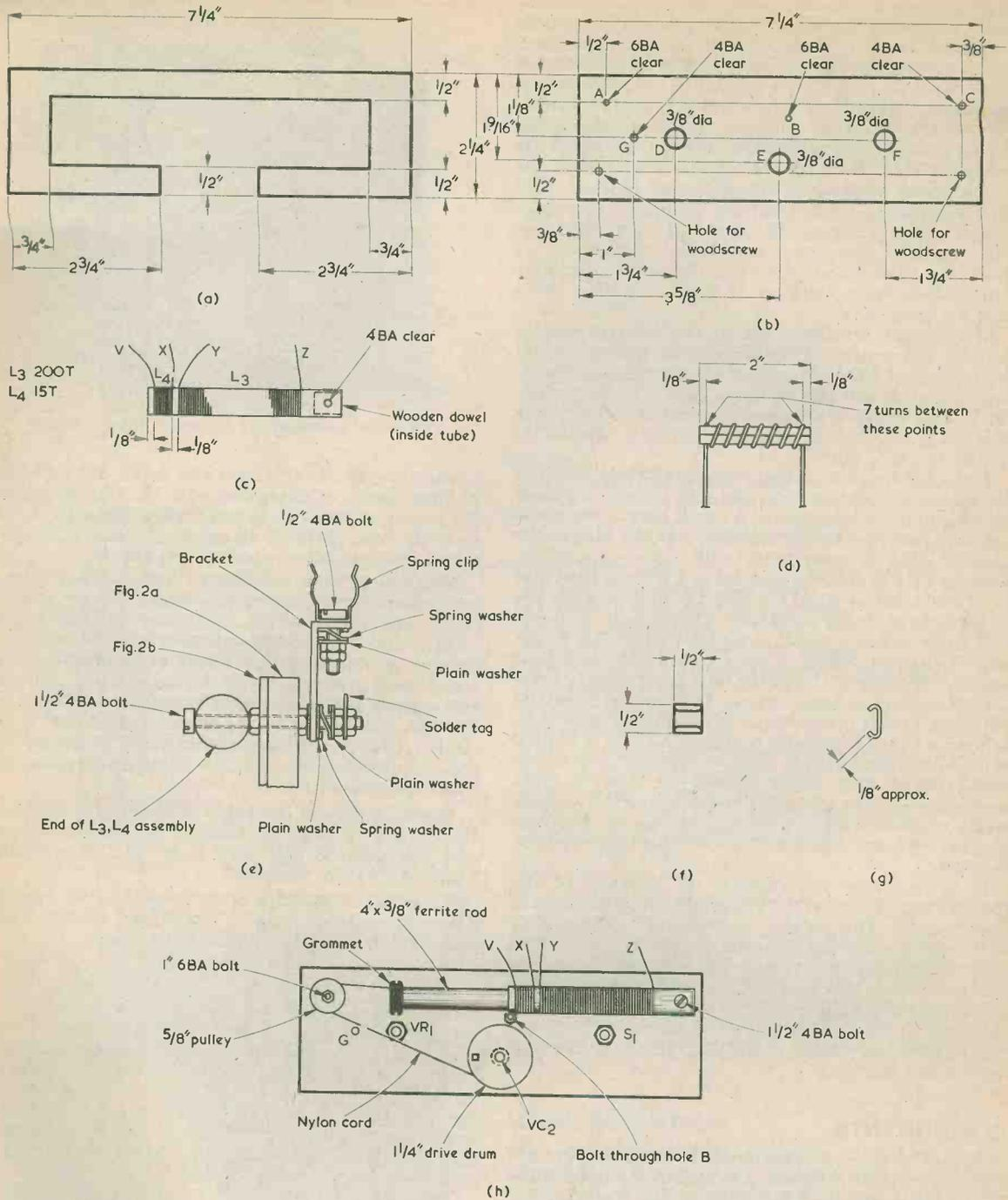

Fig. 2(a). Plywood item, on which are mounted the tagstrips for the tuner section of the receiver

(b). The s.r.b.p. panel which takes the three controls

(c). Details of coils L3 and L4

(d). The v.h.f. coil, L2

(e). The bracket and spring clip for the telescopic aerial are assembled as shown here

(f). Aluminium U-piece which secures the aerial in the spring clip

(g). Side view of the U-piece

(h). The ferrite rod moves in and out of the L3, L4 assembly as the spindle of VC2 is rotated

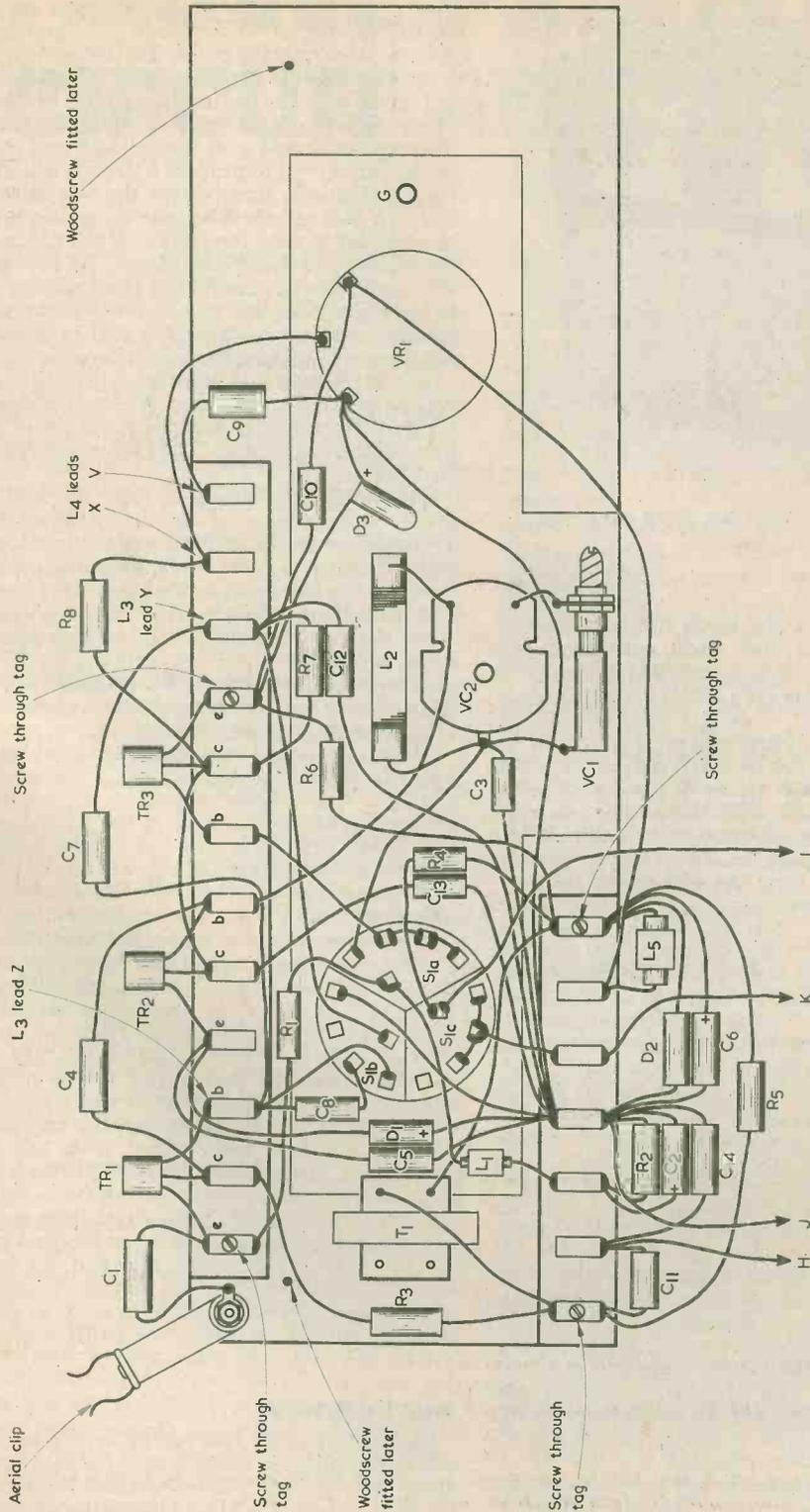
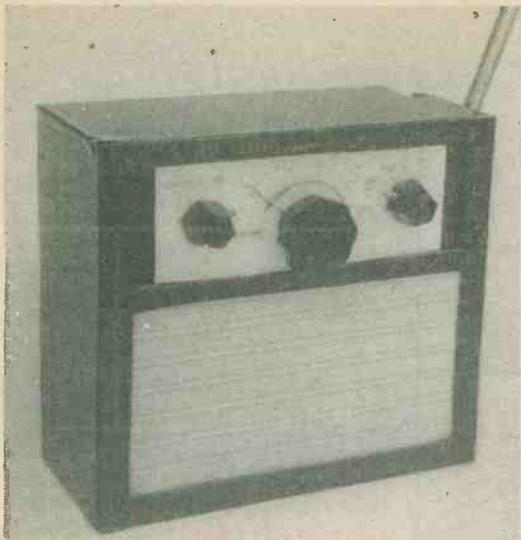

Fig. 3. Layout and wiring in the r.f. and detector stages. Connect D2 with the polarity shown in Fig. 1. Confirm with a continuity tester the inner and corresponding outer tags of the switch used for S1 before wiring to this component. The letters H, J, K and L refer to Fig. 4, which will be published next month



Here the telescopic aerial has been extended for f.m. reception

same direction, wind on 200 turns of the same wire, again in a single layer and again with each turn touching the next. The coil ends are held in place with Sellotape. These two coils are L4 and L3 respectively. Remove the ferrite rod. Cut a $\frac{1}{2}$ in. length of $\frac{3}{8}$ in. diameter round wood dowelling and insert it in the tube end remote from L4. A few turns of Sellotape around the dowelling will make it a snug fit in the tube, and its end is flush with the end of the tube. Drill a hole through the tube and dowelling to take a 4BA bolt. The hole should be through the centre of the dowelling, i.e. $\frac{1}{4}$ in. from the end of the tube.

L2 is wound on a former which is taken from a used "Bic" ball-point pen. Cut a 2 in. length of the outer casing of a transparent "Bic" pen and drill two $\frac{1}{16}$ in. holes in it, $\frac{1}{8}$ in. from each end. Take a length of tinned copper wire of about 22 s.w.g. — the gauge is not very critical — and wind on 7 turns equi-spaced along the rod, ignoring the halfturn which will pass through the holes at each end. See Fig. 2(d).

Mount VR1, VC2 and S1 as shown in Fig. 2(h), in which view the spindles point towards the reader. The wiring diagram of Fig. 3 shows the required orientation of the bodies of VC2 and VR1. Fit the drum to the spindle of VC2, keeping it well up to the bush. Take a 6BA bolt 1 in. long, pass it through hole A with the head underneath, fit a nut on the top side and tighten it.

Pass a $1\frac{1}{2}$ in. long 4BA bolt through the hole in the end of the L3, L4 assembly, fit a nut and tighten these up. Pass the end of the bolt through hole C then fit on the underside the various nuts, washers and bracket shown in Fig. 2(e). Also, fit the spring clip to the bracket, as illustrated. The two spring washers need to be fairly tightly compressed as the spring clip has to take the weight of the extended aerial in any reasonable attitude within its range.

Put a tight fitting grommet over the end of the ferrite rod, trapping under it one end of a length of nylon cord. Put two nuts over the 6BA bolt at hole A, put on the pulley and then two more nuts. (The pulley

is supplied with a fixing rivet which is not required here.) Leave all four nuts loose for the time being. Pass the cord over the pulley and then onto the drum on the spindle of VC2, passing it through the drum hole to the anchoring point. Tie the cord end such that a little less than a complete turn is on the drum when the latter is at the anticlockwise end of the operating range. A fairly light rubber band (not shown in the diagram) is passed over the coil end and the grommet on the ferrite rod to provide a tension which draws the rod into the coil. Now tighten the two pairs of nuts on the 6BA bolt at hole A so that the pulley is at the best position for smooth movement of the rod in and out of the coil as VC2 spindle is rotated. When finally set up, VC2 should be at maximum capacitance when the rod is fully into the coil tube. It will be found that the spindle of VC2 is sufficiently stiff to ensure that the rod does not pull into the tube after it has been set up.

Now drill hole B in such a position that a 1 in. 6BA bolt passed through it with the head underneath will support the weight of the coil assembly at its end and prevent it from sagging. The bolt is secured with a nut on the top.

The small item shown in Figs. 2(f) and (g) is next made. Take a piece of aluminium of approximately 18 to 22 s.w.g. and cut out a strip $1\frac{1}{2}$ in. long by $\frac{1}{2}$ in. wide. Bend it to form three sides of a square of $\frac{1}{4}$ in. side, cut the two arms so that they are about $\frac{1}{8}$ in. long and bend them inwards. This item is passed over the outer ends of the spring clip of Fig. 2(e) when the aerial is fitted to it, and prevents the clip from tending to open with the weight of the extended aerial. It may be necessary to make several of these items before one offering a good fit is achieved.

Take up the 18 way tagboard and cut out two tagstrips from this, one having 12 tags and the other having 7 tags. These tagstrips are secured to the plywood piece of Fig. 2(a) in the positions shown in Fig. 3, but first stick strips of Fablon to the wood so that the undersides of the tags are not in contact with it. The tagstrips are held down by small woodscrews passed through the tag holes indicated, and it is of no consequence that the particular tags chosen are in contact with the wood. Small holes are also drilled through the wood and s.r.b.p. panel at the centres of tags 3, 10, 11 and 12 of the 12 way tagstrip, reading from the left. The four leads from L3 and L4 pass through these holes and connect to the tags concerned.

Transformer T1 is secured to the plywood with adhesive. The colour coding for this transformer does not appear to be consistent, and the tags for the large winding are best determined with the aid of an ohmmeter. The winding concerned has a resistance lying between some 3k Ω and 5k Ω .

The components are next wired up as shown in Fig. 3, and it will be noted that L2 is secured by its lead-out wires. In the diagram, many of the components are shown outside the panel for reasons of clarity, but in practice all leads should be as short as possible and all parts should be within the panel borders.

NEXT MONTH

In next month's concluding article we shall complete the constructional details for this receiver. The references in Fig. 3 to leads H, J, K and L and the woodscrew which is fitted later will also be explained.

(To be concluded)

NOVEL PRINTED CIRCUIT ASSEMBLY

By T. E. Millsom

The unusual method of printed board assembly to be described is, in the writer's view, a great deal easier than conventional approaches, which require considerable accuracy in laying-out, etching and drilling, and which also offer considerable obstacles to fault rectification and the removal of defective components. Veroboard of 0.1in. pitch solves the problem of hole positioning accuracy but the difficulty of rectifying faults remains, since multi-pin components are hard to remove without damage to the component or the board.

The author developed his present technique to overcome these snags.

THE METHOD

Fundamentally the method is based on the fact that integrated circuits have a top surface which is sufficiently large to be glued. All the i.c.'s in a circuit are glued upside-down, usually on the plain side of a printed board. Interconnections are made by soldering fine wire to the pins.

The copper side of the board has its etched copper pattern laid out to take all the other components, such as transistors, capacitors and resistors, etc. These are positioned on the copper side of the board instead of on the plain side. This is again unconventional, but it must be remembered that the conventional method of printed board assembly stems from commercial factory practice, in which all the component leads are passed through holes in the board before the board passes over the solder bath or solder wave. With the author's approach the only holes required in the board are those through which pass wires to the i.c.'s on the plain side.

Having components on the copper side of the board could well lead to better performance at high radio frequencies. Also, as both sides of the board are used, one for i.c.'s and the other for the remaining components, the overall packing density can be high, resulting in very compact assemblies.

When there are only a very few i.c.'s it may be more convenient to glue them to the etched copper side. Only one side of the board is then used and there are no holes at all to drill.

In a few cases, mainly when logic i.c.'s are used without any other components, it is possible to employ a plain s.r.b.p. board with no copper at all. Any copper needed for terminals, i.e. supply rail connections, etc., can simply be small pieces of copper-clad board similarly glued on.

COPPER PATTERN

Working out the copper pattern can be carried out in the following manner. First draw out the i.c. layout on a thin piece of paper, by drawing the i.c. outlines. Add an asterisk alongside pin 1 of each i.c. This side of the paper represents the "i.c. side" of the board. Turn the paper over. The i.c. markings should be visible through the paper and these are again drawn in to make them more distinct. This side of the paper corresponds to the "copper side" of the board. On the paper work out the copper layout for this side of the board, positioning components at the desired positions relative to each i.c., and mark out the holes for the interconnecting wires. Drill out the holes then etch the copper to the pattern which has been marked out.

Solder the components to the copper side. The author pre-forms the lead-outs so that the components stand slightly clear of the board. This keeps the component bodies away from solder and copper and is helpful if any component has to be removed. Also, repairs and modifications can be quickly and easily carried out. When closely spaced, transistor lead-outs can be covered with sleeving. On the plain side of the board the i.c.'s are stuck down with several "dabs" of an impact adhesive, such as Evostick. They can be removed later, if necessary, by prising. Take care to ensure that pin 1 of each i.c. takes up its proper position on the board.

Interconnection can be carried out with fine tinned copper wire, and the author uses strands of wire taken from mains flex. This is adequate for all instances except the few where sizeable currents are liable to flow, whereupon a thicker tinned copper wire of appropriate gauge is used. Soldering to the i.c.'s is easier than with a standard printed board assembly as there is no support which allows solder to bridge over to closely adjacent copper areas. A loop of wire is slipped over an i.c. pin and quickly held by a spot of solder. This operation is fast because the wire is so thin. The main precaution is to keep the soldering iron bit constantly wiped clean so that it never carries an excess of solder. It is necessary, of course, to remember that the i.c. pin numbering proceeds in the opposite direction to that in the i.c. data, which normally shows a top view.

This general approach, admittedly unorthodox, has been used successfully for quite a large number of assemblies. It may well recommend itself to readers including, in particular, those who find much of their pleasure in experimental work. ■

NEWS . . . AND

NEW INSTRUMENT REPAIR CENTRE

Thorn Automation Limited, Rugeley, has formed an instrument repair centre to be known as The Midlands Instrument Repair Centre, for all models of Avo and Megger Instruments.

This new repair facility is a self-contained operating unit within the company's Rugeley site, and

provides a rapid repair and calibration service to instrument users.

The centre has been appointed as an "authorised service organisation" under the auspices of London Instrument Repair Centre; the manufacturers joint service organisation for Avo and Megger Instruments.

It is fully equipped and operates to standards set by the manufacturers, and it can provide a "while-you-wait" repair service by appointment. Also, regular maintenance and calibration contracts are undertaken and the centre can attend to warranty claims.

When the instruments are received, the repair, re-calibration and refurbishment are carried out and the customer invoiced in the usual way. This ensures the fastest possible turn round for the instruments. However, if the cost of this work is going to exceed approx. 40 per cent of the list price for a new instrument, the user is advised before the work commences so that he can confirm what action he requires. Alternatively, the customer can request a quotation before any work is done.

After repair and/or calibration of an Avo or Megger instrument, a Certificate of Conformity can be provided by the new centre.

Thorn Automation plans to expand the facilities within the Midlands Instrument Repair Centre so that it is equipped and capable of providing a service for other instruments.



Checking a Model 8, Mark 3 AVO in the new Midlands Instrument Repair Centre at Rugeley

OUR NEXT ISSUE

Commencing with next month's issue we are increasing the page size of this magazine without any increase in cover price.

We are particularly pleased to make this advance in Jubilee Year.

Order now to make sure of receiving your copy.

CABLE CONNECTORS FOR BATTERY OPERATED VEHICLES

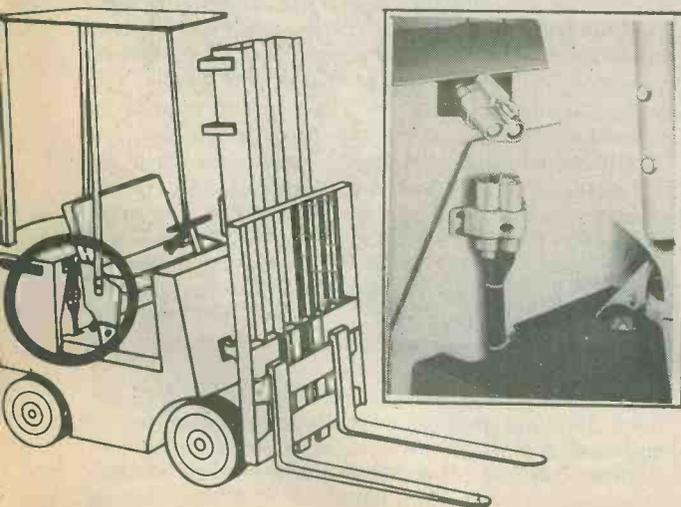

Lee Green Precision Industries Limited offers a new non-arcing cable connector for battery operated vehicles which eliminates the two major causes of vehicle connector failures — pulling the connectors apart while under load, and — vibration of the connector contacts when the vehicle is in motion.

Non-arcing is achieved through a polarizing plunger on the male connector which activates a limit switch in the female connector. If the connector is disengaged under load the limit switch drops out the main circuit power before the connector contacts separate. Likewise, when making a connection, the limit switch will not permit main circuit power to flow through the connector contacts until they are fully engaged. An emergency quick-disconnect is also available should the main vehicle contacts stick or weld shut. A quick pull on the lever disconnects the battery.

Cam-lok battery connectors are available for electrical service up to 350-amperes at 72 volts. Write for catalogue No. 824 to Lee Green Precision Instruments Ltd., Grottes Place, Blackheath, London, SE3 0RA.

COMMENT

LIQUID CRYSTAL DISPLAY SCIENTIFIC CALCULATOR

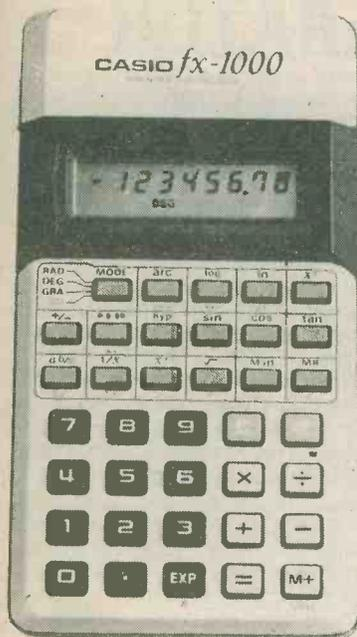

Casio announce their FX1000 Liquid Crystal Display Scientific Calculator.

Very small — just 5in. x 2½in. x ½in, light — just 3.30zs (including battery). 24 important and regularly used scientific functions, including sin, cos, tan, arc sin, arc cos, arc tan, sinh, cosh, tanh arc sinh, arc cosh, arc tanh, log, ln, sexagesimal, \leftrightarrow decimal conversion, ex, 10^x, xy, x^{1/y}, x^{1/}, 1/x, Rad./Deg./Grad, etc.

For further details write to: Casio Electronics Company Limited, 28 Scrutton Street, London EC2.

B.A.E.C. EXHIBITION 1977

The Annual Exhibition of the British Amateur Electronics Club will again be held in the Shelter, The Esplanade, Penarth, S. Glam. from 16th to 23rd July.

This is the club's twelfth exhibition and their popularity is vouched for by the large sums they have raised for charity.

Readers on holiday in South Wales should pay the exhibition a visit.

SILVER JUBILEE

Radio Amateurs in the U.K. have had the opportunity of celebrating the Silver Jubilee of Her Majesty Queen Elizabeth II by their use of the prefix GE when working a station outside the U.K., during the period 4th to 12th June.

We are marking this year of celebration by publishing in this issue "The 'Jubilee' A.M.-F.M. Receiver", by Sir Douglas Hall, K.C.M.G., and accompanying it with a specially designed cover. Long may she reign.

HOME ENTERTAINMENT WEEK

Britain's tv and radio manufacturers, distributors and retailers will be after your eyes and ears next September 4 to 11!

They're staging a spectacular Home Entertainment Week — a nationwide drive to sell more colour tv, tv games, hi-fi, electronic musical instruments, video recorders, sound recorders, radios and calculators.

Electronics have revolutionised home entertainment; and with the rising cost of holidays, theatres, dining out and entertaining, many thousands of people are turning to the newer forms of audio and video diversion as a means of unwinding after a hard day's work.

In a concerted, industry-backed promotion, dealers up and down the country will be staging special displays, parades and local exhibitions during Home Entertainment Week, showing and demonstrating the latest ranges of equipment. The climax will be Audio Fair 77, the great annual Home Entertainment exhibition opening at Olympia, London on September 12.

CLUB NEWS

● Members of the St. Dunstan's Amateur Radio Society, gathered at Ian Fraser House, Ovingdean, near Brighton, for one of their quarterly meetings over the weekend of May 20-22.

The afternoon lectures given by Ron Ham for blind amateurs was recorded. During the meeting Joan Ham showed the St. Dunstaners a selection of wartime morse keys, including one from the First World War, owned by the late Nelly Corry, G2YL, and featured in 'R&EC', August 1976.

It is proposed to set up a permanent amateur radio station at Ovingdean, and have it operational by the end of the year.

● The inaugural meeting of the newly formed Brighton and District Radio Society, took place on May 18th, at the St. John the Baptist Social Club Hall, Bristol Road, Brighton.

About 30 people attended the first meeting to elect officers and approve a constitution. Details of their future programme are available from Nigel Hewitt, G8JFT, 74 Carlyle Street, Brighton.



"Say, Warden, this is dangerous — it could kill someone!"

No. 2

SQUARE WAVE GENERATOR

by I. R. Sinclair

Circuits which generate a square wave at an audio frequency are very useful for circuit checking since the mixture of harmonics in a square wave can extend well into the radio frequencies, allowing r.f., i.f. and a.f. amplifying stages to be checked. The steeper the slope of the sides of the square wave, the greater the number of high harmonics present, so that a generator of this kind should preferably give a square wave with really fast rise and fall times, as in Fig. 1(a).

The simple multivibrator circuit which is usually used for this application is not ideal because although the fall time is fast the rise time of the square wave is rather slow, giving the effect shown in Fig. 1(b). This makes the output unsuitable for such jobs as checking audio amplifiers (using a square wave input and an oscilloscope at the output) since the shape of the square wave is poor to start with.

BETTER WAVESHAPES

The circuit of Fig. 2 gives a square wave whose fundamental frequency is about 400Hz, and the shape of the wave is better than that given by the simpler type of design. In addition, the circuit is designed so that the waveshape and frequency are less affected by changes of power supply voltage.

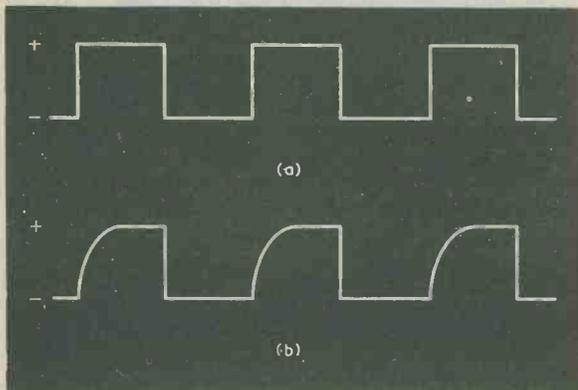

Fig. 1(a). A square wave with ideal shape
 (b). The waveshape produced by most simple multivibrator circuits

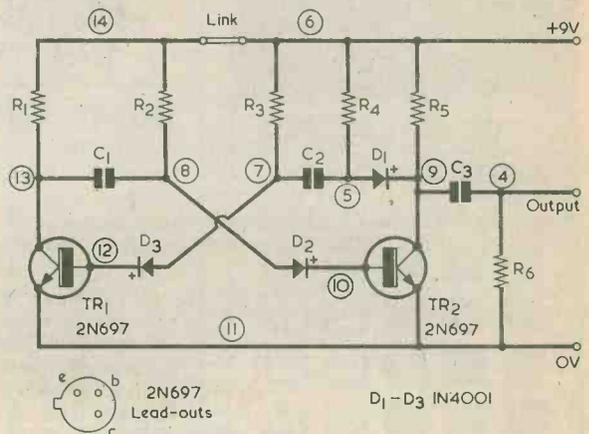

Fig. 2. Circuit of improved square wave generator, with Blob Board track numbers circled

COMPONENTS

Resistors

(All 1/4 watt 10%)

- R1 6.8kΩ
- R2 56kΩ
- R3 56kΩ
- R4 4.7kΩ
- R5 6.8kΩ
- R6 56kΩ

Capacitors

- C1 0.022μF polyester
- C2 0.022μF polyester
- C3 0.1μF polyester

Semiconductors

- TR1 2N697
- TR2 2N697
- D1 1N4001
- D2 1N4001
- D3 1N4001

Blob Board

Blob Board type ZB-2V5

In this second article in our Blob Board series we present a square wave generator which offers a particularly good output waveform. The main purpose of the generator is to function as a signal injector.

Dealing with the rise time problem first, this arises from the action of the multivibrator when one transistor shuts off. Imagine for a moment that TR2 of Fig. 3 is about to shut off. Before this happens its collector will be at a low voltage, around 0.2 volt, with the base of TR1 just coming up to 0.6 volt. When TR1 turns on TR2 shuts off and its collector voltage starts to rise, but the base voltage of TR1 remains at a level of around 0.6 volt. Because of this, current must flow through RA to charge CA as TR2 collector voltage rises. It is this action of charging the cross-coupling capacitor which slows the rise time of the wave at TR2 collector.

This effect has been avoided by using the circuit at the collector of TR2 which is shown in Fig. 2. When TR2 switches off its collector voltage can rise very quickly, because it is isolated from C2 by the diode D1 which is now reverse biased. C2 charges up comparatively slowly through R4 (instead of through R5) but with no effect on the waveform at the output, and this arrangement gives very steeply sloping rising sides to the output square wave.

The other problem which affects the simple multivibrator design is the reverse base-emitter breakdown voltage of silicon transistors. At this voltage the base-emitter junction behaves like a zener diode. The base-emitter junction of silicon n.p.n. transistors such as the 2N697 breaks down at a surprisingly low voltage, and this can be as small as 5 volts. Now when one transistor in the multivibrator turns on its collector voltage falls from the supply voltage (9 volts) to about 0.2 volt; a fall of 8.8 volts. The base voltage of the *other* transistor should fall by exactly the same amount because of the capacitive coupling, whereupon it should go from 0.6 volt to -8.2 volts. Because of the base-emitter breakdown, however, the base voltage can stick at, say, about -6 volts, so that multivibrators using a simple circuit seldom work at the designed frequency or have a good waveshape. In addition, the reverse breakdown causes the frequency and waveshape to change with applied voltage when that voltage is significantly greater than about 5 volts.

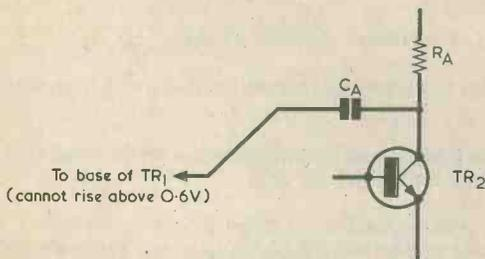

Fig. 3. Why a simple multivibrator circuit gives a slowly rising leading edge to its square wave

In our circuit, this problem has been solved using diodes D2 and D3. These prevent the bases of the transistors from being driven negative, since the diodes have much higher breakdown voltages than the transistor junctions. The diodes are sometimes placed in the emitter circuits, but with the slight disadvantage that they then carry the emitter current of the transistor.

BLOB BOARD ASSEMBLY

We can build the circuit very easily on a piece of ZB-2V5 Blob Board, using the track numbering shown in Fig. 2. In this circuit, the arrangement has been designed to keep the transistor leads short so that short lead transistors can be used. Note that lines 6 and 14 must be joined by a wire bridge, and that line 6 connects to supply positive.

Start construction by cutting the resistor leads to size. R1 must be mounted end on, i.e. vertical, to the board, since it is soldered between tracks 13 and 14; R4 is similarly mounted end on between tracks 5 and 6, as is R3 between tracks 6 and 7. The remaining resistors can be mounted parallel to the board. Cut a length of insulated wire to bridge between track 6 and track 14, and strip just enough insulation from its ends to enable these to be blobbed in place. (Part 1 gave a description of the blobbing technique.) With the resistor wires cut, tin the ends of the leads with a hot iron and fresh solder, and blob each of them into place on the Blob Board. Any part of the board may be used providing the resistors are connected between the correct tracks, but it makes for neater construction if the resistors are kept as close together as is reasonably possible. However, they should not be so close that they cannot be replaced, if necessary. Fig. 4 shows a recommended layout on the Blob Board.

Now prepare the capacitors and diodes. The capacitors may be mounted either way round but the diodes must be connected with correct polarity, the lead at the end with the white band, which indicates the cathode, being soldered to the right track. This is track 12 for D3, 10 for D2 and 9 for D1. Blob these components in place.

Finally, prepare the transistor leads, cutting them fairly short and tinning the ends. Again, the transistors are blobbed into place with the emitter of TR1 on track 11, its base on track 12 and its collector on track 13. TR2 is soldered on with its emitter on track 11, its base on track 10 and its collector on track 9.

The supply leads can now be connected, with the positive lead taken to track 6 and the negative lead to track 11. The output, which may be on a probe or a coaxial cable, is taken from track 4. If a coaxial cable is used, its braiding connects to track 11.

With a simple project of this nature it is only necessary that the components be connected to the correct tracks. In the sample shown in the photograph the layout differs from that in Fig. 4 so far as relative component positioning is concerned;

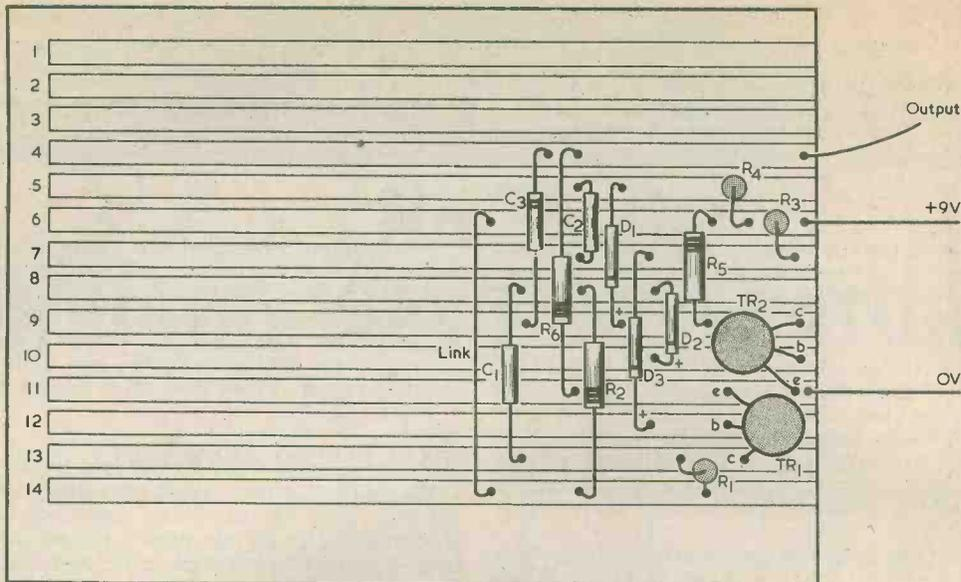
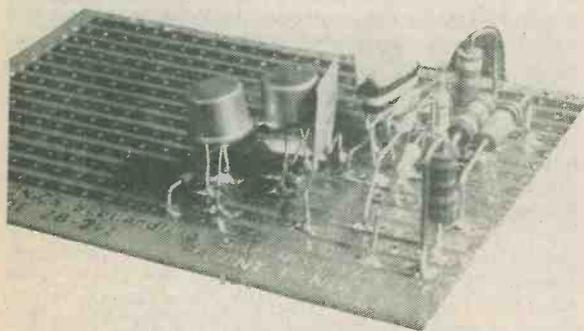

Fig. 4. Practical layout on a ZB-2V5 Blob Board

although the same tracks are employed. The layout of Fig. 4 is recommended since the transistors are

near the edge of the board and it is then easier to reach the three leads of each with the soldering iron.



The components for the signal injector are readily soldered to the Blob Board. The main requirement is that connections are made to the track numbers shown in the circuit diagram

TESTING

After completion the circuit can be tested by connecting a red probe lead to the output on track 4 and a black probe lead to track 11. With a 9 volt battery connected with the correct polarity to the multivibrator, the signal can be detected by taking the probes near a working transistor medium and long wave radio, or by injecting into any stage of a transistor audio amplifier, with the black probe on the chassis line of the amplifier and the red probe on the appropriate input point. Since the square wave is at high amplitude care should be taken not to overload the amplifier. Alternatively, a miniature earpiece from a transistor radio can be connected between tracks 4 and 11, when a loud tone will be heard.

The circuit can, if desired, be permanently mounted in a small metal or plastic box with a PP3 battery and an on-off switch in series with the positive supply. Since one side of the Blob Board is plain it can be glued to a metal surface. Current consumption is approximately 1.5mA. ■

BACK NUMBERS

For the benefit of new readers we would draw attention to our back number service.

We retain past issues for a period of two years and we can, occasionally, supply copies more than two years old. The cost is 40p plus 12p postage.

Before undertaking any constructional project described in a back issue, it must be borne in mind that components readily available at the time of publication may no longer be so.

We regret that we are unable to supply photo copies of articles where an issue is not available. Libraries and members of local radio clubs can often be very helpful where an issue is not available for sale.

SUGGESTED CIRCUIT

4-STEP CMOS SEQUENCE SWITCH

By G. A. French

In last month's article in the "Suggested Circuit" series we examined the CMOS digital integrated circuit type CD4018. This is a presettable divide-by-N device and it can be made to divide by 2, 4, 6, 8 and 10 by connecting the appropriate not-Q output to its data input. Normally, the divided output is taken from the not-Q pin which is coupled back to the data input but we were more interested, last month, in the outputs which appear at the other not-Q pins. This information is not readily perceivable in the manufacturer's literature on the CD4018, and so a series of truth tables, illustrating the outputs given, were prepared by means of experimental observation. The results showed that the CD4018, which is already an extremely versatile i.c., can be made even more versatile by taking advantage of the not-Q outputs which are not normally employed in simple dividing circuits.

In this article we shall proceed further with the story and investigate a method of using the CD4018, in company with a quad 2-input NAND gate, so that it provides a 4-step sequence function.

TRUTH TABLE

To achieve a 4-step sequence, it is necessary to have the CD4018 function as a divide-by-4 device, and this is accomplished by connecting the not-Q2 output to the data input. The outputs appearing at all the not-Q pins are then given in the accompanying truth table. The device is taken one step forward at a time by applying a positive-going pulse to its clock input.

Step 1, given by setting the reset input to high and then low again (or, possibly fortuitously, after switching on the supply) has all not-Q outputs in the high state. The output at the not-Q2 pin then follows the divide-by-4

procedure for all successive steps. If, however, we take the other not-Q outputs into account we find that, after Step 3, these fall into an overall pattern which continually repeats itself. Step 8 is the same as Step 4, Step 9 will be the same as Step 5 and so on.

We could obtain a 4-step sequence function simply by taking outputs from not-Q1 and not-Q2, using say a number of 2-input NAND gates, but we would require two inverters to deal with the two lows which appear at Steps 3 and 7. It would be more economic of components if, instead, we take advantage of the high outputs which are already available on the CD4018 not-Q pins. If we wished to couple a quad 2-input NAND gate to the CD4018 to obtain the 4-step sequence all we have to do are find two highs for each step in the truth table which differ in position from the highs in the other steps. If these two highs are applied to the inputs of a NAND gate, its output will then go low for that step.

A little examination soon shows that the highs we require are readily available. At Step 4, they appear at outputs 1 and 4; at Step 5 they turn up at outputs 1 and 2; at Step 6 we find them at outputs 2 and 3; and at Step 7 they are present at outputs 3 and 4. All we have to do is to connect these outputs to four 2-input NAND gates and we have succeeded in setting up a sequence switch.

PRACTICAL CIRCUIT

Fig. 1 shows a practical working circuit which has been checked out by the writer. It will run satisfactorily from a 9 volt battery, and C1 functions as a bypass capacitor connected across the supply rails.

IC1 is a 555 timer which produces positive pulses for application to the clock input of the CD4018. It is connected in a standard astable multivibrator circuit, in which C2 is the charge and discharge capacitor. The value of C2 is chosen such that the running frequency of the 555 suits the particular application for which the sequence switching circuit is to be used.

The output of the 555 is fed to the clock input of the CD4018 at pin 14. All the "jam" inputs of this i.c., as well as the reset and preset pins, are taken to the negative supply rail. The not-Q2 output at pin 4 is taken to the data input at pin 1. No connection is made to the not-Q5 output at pin 13, and no use is made of this output in the present circuit.

IC3 is a CD4011, another CMOS device. The inputs of the uppermost gate in the diagram connect to the not-Q1 and not-Q4 outputs. The second gate has its inputs coupled to the not-Q1 and not-Q2 outputs, whilst the third gate couples to the not-Q2 and not-Q3 outputs. The bottom gate connects to the not-Q3 and not-Q4 out-

CD4018 TRUTH TABLE

Not-Q2 Connected to Data Input

Step	Not-Q outputs				
	1	2	3	4	5
1	H	H	H	H	H
2	L	H	H	H	H
3	L	L	H	H	H
4	H	L	L	H	H
5	H	H	L	L	H
6	L	H	H	L	L
7	L	L	H	H	L
8	H	L	L	H	H

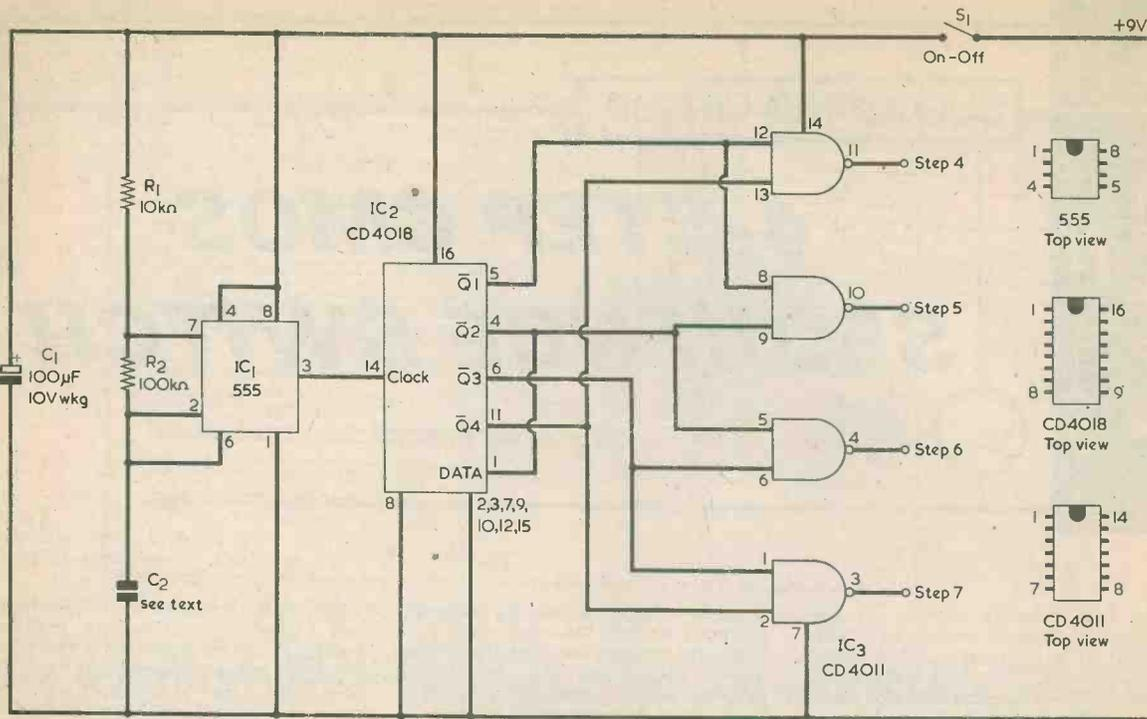

Fig. 1. Basic circuit of the 4-step sequence switch. The four NAND gate outputs go low successively

puts. These connections correspond to the highs in successive steps, from 4 to 7, in the truth table.

After switch-on the circuit will pass through several cycles before settling

down to the pattern shown in the table. Then, each NAND gate output will go low in sequence, following the succession: pin 11, pin 10, pin 4, pin 3, pin 11, pin 10 and so on.

APPLICATIONS

A possible application consists of having the NAND gate outputs control a series of lights arranged in a circle or in a rectangle, as in Fig. 2. If these are connected up in the requisite manner they can be made to light up in turn, giving the appearance of lights running around the circle or rectangle. Such an array affords an attention-catching display in a shop window. The lamps employed are actually light-emitting diodes, and in Fig. 2 diodes D2A, D2B, D2C and D2D are illuminated. When they extinguish, the D3 diodes will light up, followed by the D4 diodes and then the D1 diodes.

The diode drive circuit is shown in Fig. 3. The current capability of the NAND gate outputs of Fig. 1 is too low to enable them to drive the l.e.d.'s directly and so each output is coupled via a 10kΩ resistor to a p.n.p. transistor connected in the common emitter mode. As each NAND gate goes low it turns on the corresponding transistor which then causes the l.e.d.'s in its collector circuit to light up. R7 to R10 are current limiting resistors and their values are given for series chains of 2 to 4 l.e.d.'s in each section. (An application in which only one l.e.d. per section is lit up is described later).

Although as many as 16 l.e.d.'s can be employed in the circuit of Fig. 3 the current drawn from the 9 volt supply is quite low. The 555 timer draws about 6mA whilst each chain of l.e.d.'s

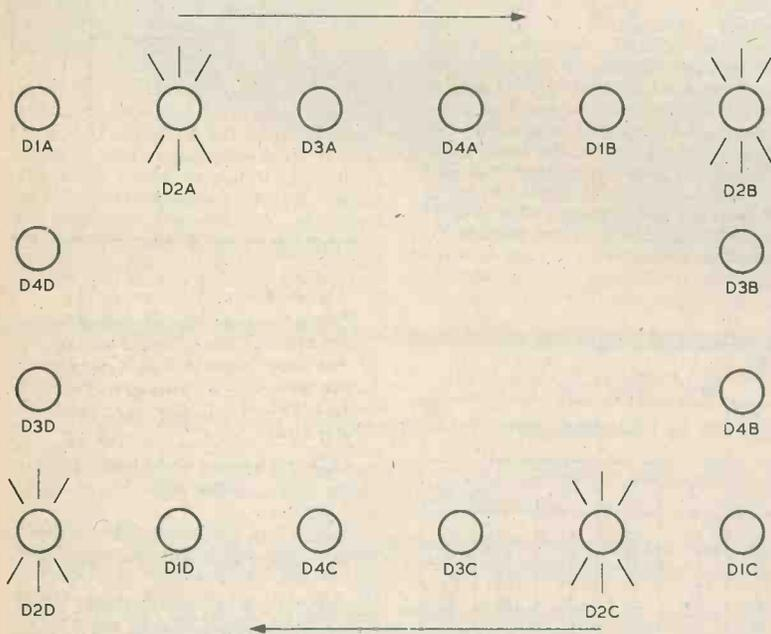

Fig. 2. A simple display in which l.e.d.'s are lit in succession, giving the impression of a light moving around the rectangle

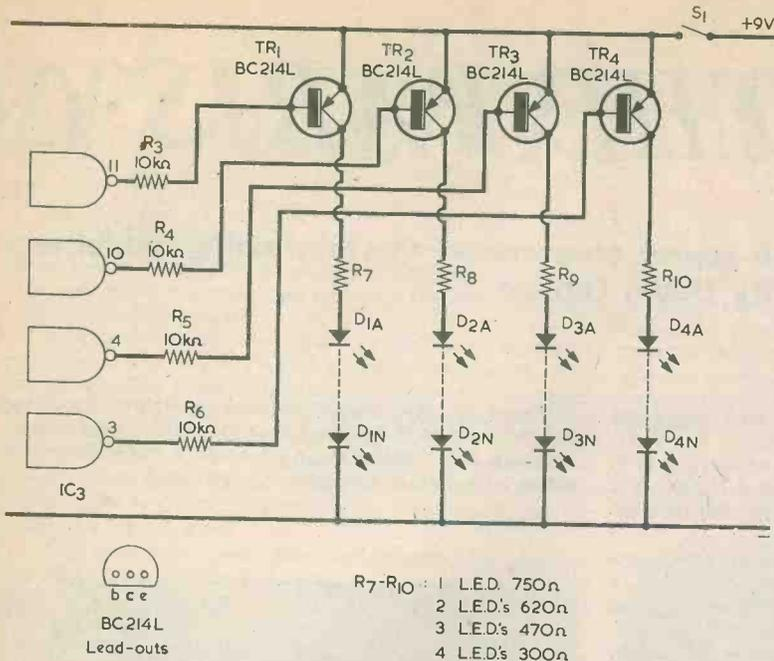

Fig. 3. A transistor driving circuit suitable for running the l.e.d.'s of Fig. 2

draws approximately 10mA. Apart from the output current of slightly less than 1mA in R3 to R6, the current drawn by the two CMOS i.c.'s is negligibly low. Since only one chain of l.e.d.'s is alight at any given time, the total consumption of the circuit is around 17mA only.

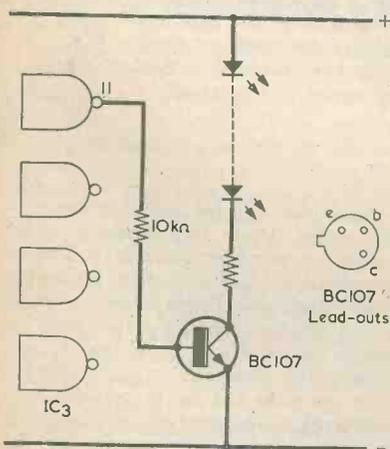

Fig. 4. The l.e.d.'s may alternatively be illuminated when the appropriate NAND gate output is high

The number of l.e.d.'s in each chain can be increased by increasing supply voltage by 1.5 volts for each l.e.d. The supply voltage must not exceed 15 volts, which is the absolute maximum rating for the two CMOS devices.

The speed with which the lights "move" around the circle or rectangle of l.e.d.'s depends on the value of C2. The author found that a value of 1μF here, which gives a 555 running frequency of approximately 7Hz, gave a satisfactory speed, but higher or lower values can be tried, if desired. If an electrolytic capacitor is employed for C2 its negative lead-out connects, of course, to the negative supply rail.

It is possible to have only one l.e.d. chain extinguished at a time so that the moving light is represented by groups of three l.e.d.'s being illuminated. The requisite circuit for one chain is shown in Fig. 4 and the principle is the same as that of Fig. 3 except that the transistor is now turned off when the output of the associated NAND gate goes low. In the author's view the visible effect is not as striking as is given with the arrangement of Fig. 3. The current drawn from the supply is increased by about 20mA.

GAMING DEVICE

As most experienced constructors will have already assumed, the 4-step sequence switch forms an excellent basis for a simple gaming device. The output circuit of Fig. 3 is used, with only one l.e.d. being fed by each transistor. Also, as is shown in Fig. 5, the

circuit of Fig. 1 is modified by the addition of push-button S2 between the output of the 555 and the clock input of the CD4018 together with a 10kΩ resistor, R11, between the clock input and the negative supply rail. For this application C1 can have a value of 0.047μF, giving a 555 running frequency of about 150Hz. Again, current consumption from the 9 volt supply is of the order of 17mA.

When the circuit is switched on, all the four l.e.d.'s can be seen to flicker noticeably. If the push-button is pressed the drive to the CD4018 clock input ceases, and the clock input is taken low by R11. Whichever l.e.d. happened to be alight at the instant of pressing the switch remains continually illuminated, and the choice of l.e.d. is completely random.

Any small l.e.d.'s can be used for the circuits described. Those employed by the author were Type 4 diodes available from Doram Electronics. With these the anode lead, which couples to the negative supply, is shorter than the cathode lead.

The two digital i.c.'s are both CMOS types and the usual precautions should be observed when handling them. In particular, the soldering iron employed for wiring must have a reliably earthed bit. Constructors who wish to exercise a high degree of caution may employ i.c. holders, the i.c.'s being fitted to these only after all the wiring has been completed.

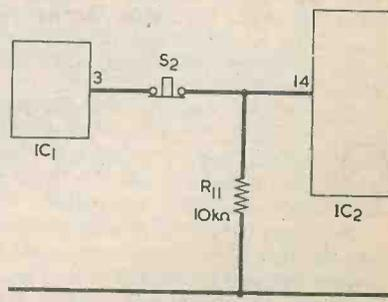

Fig. 5. A modification to the circuit of Fig. 1 which enables the sequence switch to function as a gaming device. The pulses fed to the clock input of the CD4018 are interrupted when the push-button is pressed

The applications just described are only typical of what can be offered by a 4-step sequential switch. Other ideas may suggest themselves to the reader and it should be remembered that a very wide range of cycling speeds is available simply by choosing appropriate values for C2.



THE PARIS CO

A report on some of the interesting exhibits:
By David Gibson

Despite its title — Salon International des Composants Electroniques 77 the Paris Components Show has diversified into instrumentation and production equipment. With 1,257 exhibitors and an attendance of some 75,000, this international exhibition drew displays from 30 different countries.

New products were expected, but some were almost unpronounceable! One stand, for example, showed a Psophometer. Generally speaking, psophometers are used to determine the subjective signal-to-noise ratio in communications channels where the information is received by the human ear — so there!

Hands up if you've ever wound a coil or inductor. How about winding a coil which measures only 0.13in. by 0.225in. and is variable, too! If (like me) you think it almost impossible, you'll be pleased to know that they are already manufactured by an American company. Those on show at the exhibition had inductance values from 0.018 μ H up to 1,000 μ H with a frequency range from 790kHz to 150 MHz. Inductance variation depended upon frequency involved or rather the actual nominal inductance value. For example, a 10 μ H coil was variable from 11.2 μ H to 8.8 μ H, while an 82 μ H component could be adjusted between 100 μ H and 60 μ H.

Even more impressive, and from the same company, is a range of chip-tuned circuits. These contain a coil, which is centre-tapped, plus a resonating capacitor. The size? A diminutive 0.25in. x 0.25in. x 0.125in. high. Some of these tuned circuits are also adjustable!

How long before the Amateur constructor market sees a serious influx of miniature computers? According to one exhibitor that day is already here. The company markets a complete microcomputer which has a keyboard, display, random access memories, read only memories, microprocessor unit and interfaces for audio cassette and teleprinters. The price in France is 1,650 Francs. Mathematicians who can divide by 8½ (the approximate number of French Francs to the English pound) will make the price in pounds around £194 unless my calculator lied! Pricy, perhaps, but when one considers Radio Amateurs paying £400 for a transceiver it isn't really so costly. Various programmes are in the pipeline and the Company even has a users club where ideas are exchanged. A chess programme is one project currently under way.

Have you ever thought just how thin the layers are on an integrated circuit chip? But *exactly* how thin are they and what is their resistance? A difficult problem, unless you happen to buy an FPP-100. This instrument has a tiny head which is lowered onto the IC wafer. Immediately, the machine will give a digital readout of the resistivity of the top layer and its depth, too. It measures thickness in microns and will also measure and display metallisation

thickness in KÅ (kiloAngstroms). Imagine measuring resistance down to 1 micro-ohm and yet that's what this instrument does. Useful for measuring the thickness of the butter on a British Rail sandwich perhaps?

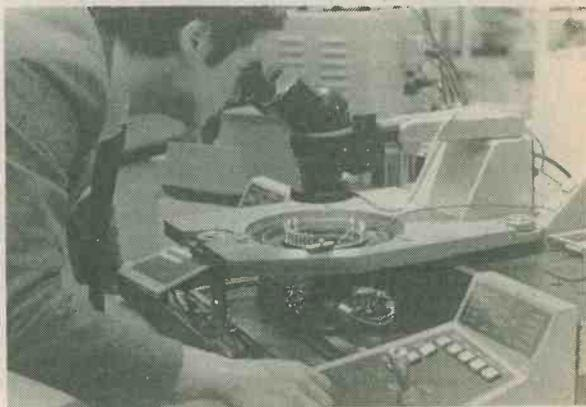

With the aid of a binocular microscope, an operator can lower a set of tiny probes onto an IC wafer containing hundreds of minute ICs. The probes can be lowered onto individual ICs on the wafer to test them

Electronic games reared their playful heads. In one corner was a Grand Prix racing game. This device is novel because it does not require a television receiver. It is complete and compact — about the size of a small electronic calculator. There is a race track which goes up the centre of the unit. Realistic sound effects accompany the game. A four position gear change allows one to 'drive' the car and it's also possible to 'crash'. This should be on the market by Christmas this year but the price has yet to be fixed.

With the advent of the microprocessor and a decrease in the price of larger memories, it is almost certain that TV games will grow increasingly complex. The path is tending now towards a complex unit which can be programmed, by the user, to give various games. Eventually, the manufacturers either directly or by arrangement, will be marketing a range of tape cassettes which will hold various programmes for these games. One will simply 'play' the cassette to the

COMPONENTS SHOW

games unit and start to play. Already, one major manufacturer has programmed a single chip microcomputer to play the card game blackjack, and to mimic the action of a pin ball arcade fruit machine.

An interesting chip was the AY-1-1320 which simulates the sound and touch of hammer-action instruments, such as a piano. The result is an electronic piano which is touch sensitive i.e. the harder the touch on the keys the louder the note which also dies away automatically like a real piano. The manufacturers claim that an electronic piano using this device could easily be built for £100 and already one very large order has been placed for this chip: watch out for complete kits of parts!

The electronic piano chip incorporates 12 separate envelope generation circuits for octave tones and semitones. A five octave instrument would require five of these devices which are packaged in a 40-pin dual-in-line housing. The actual touch, or key velocity is sensed by a switching arrangement which connects the input circuitry to the negative supply in the rest position, and to ground when the key is fully depressed. The chip also has a timer on it which is initiated by removal of the negative supply and stopped when the key is grounded. The time to change state is thus inversely proportional to the key velocity and can be used to control the output volume.

Output from each keying circuit is a square wave at the required fundamental frequency. This wave is shaped by external voicing circuits to produce a piano-like tone.

Many television sets today are remotely controlled, usually by a small, hand-held ultrasonic unit. Now, the idea has been extended to hi-fi. A small unit on show enabled the user to adjust a hi-fi system from an armchair. It was also possible to tune the stereo radio receiver — a complete change from Terry Wogan to Bach at the twitch of a forefinger.

Power supplies were in the news. Direct-off-line types were rife and it is predictable that these units will find their way into more domestic equipment as time passes. The D-O-L power supply accepts the mains and then switches this very fast (typically around 30kHz). The resulting switched power is fed out to a smoothing arrangement. However, since the frequency is now very high, 30kHz compared to 50Hz, the smoothing components can be very much smaller. Also, because of the higher frequency involved, small ferrite type transformers can be used instead of the huge metal-cored types employed in the more conventional type of PSU (power supply unit). Efficiency of these supplies is extremely high, typically 70% and there is an enormous reduction in both weight and size. A 5V 20A supply measures only 16 x 14.2 x 9.3cm., can be easily held in one hand.

With computers gaining greater importance in business it is becoming increasingly urgent to be able to communicate with them. Most companies keep their stock records on computer and it would be useful if a salesman in the field could access the computer to check stock and to place orders immediately etc. Now — it can be done. The TED22 portable data entry terminal fits happily into a coat pocket.

To access the computer, one merely plugs in a small ear-piece which fits exactly over the mouthpiece and/or ear-piece of a standard telephone handset. To 'chat up' his computer, a salesman simply rings it up, slips the earpiece over the telephone handset, and types in the information on the tiny keyboard. A display also permits information to be received from the computer. The complete unit runs from a standard 9V battery.



A prototype PCB is projected through a microscope/TV camera onto a large TV screen. The operator adjusts a crossed-line graticule exactly over the place where he wants a hole drilled. The digitiser punches a paper tape with an X-Y axis code. Later, the tape will feed a multi-head drilling machine via a computer and hundreds of holes will be drilled automatically and accurately to within thousandths of an inch

And so space runs out before we've covered barely a dozen stands. Sad, but there's hardly any room to mention the power supply which allows one to set the output anywhere from zero to one volt, in steps of $1\mu\text{V}$. Nor to elaborate on the battery-operated laser torch which, together with other special equipment, one can use to see in the dark even when it really is pitch black. Then there was the voltmeter which had no dial or digital readout — just LEDs. One could mention fibre optic links with transmissions over yards of fibre using light; or perhaps the pocket digital thermometer; the 'plug and socket with zero insertion and withdrawal force or the analogue to digital driver unit which can drive thirty LEDs — three rows of ten — and illuminate any one.

Never mind, in just one more short year there will be another Salon International des Composants Electroniques, and another twelve hundred stands from 30 different countries to look round. Who knows what we'll find next year?

Photographs by David Gibson

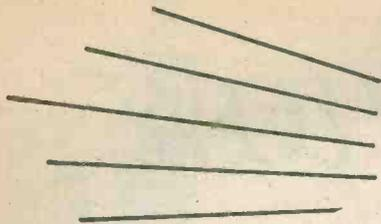

SOUND ACTIVATED SWITCH

By R. A. Penfold



Sound activated switches can be used in a number of applications, including radio communications (VOX systems) and tape recording (voice operated tape recorders). They can also be employed in burglar alarm systems, and they provide very interesting projects for the experimenter.

The unit which forms the subject of this article is a sound activated switch which can be triggered by an ordinary speaking voice at a maximum range of about 12 feet. It is based on a CA3401E quad Norton amplifier, and the only other active component which is used is a silicon transistor. The device is employed in conjunction with an external crystal microphone, but is otherwise self-contained. (Regular readers will recall that we published an article, "Using Quad Norton Amplifiers," in last month's issue which described the functioning of these amplifiers and the manner in which input impedance, gain and bias can be set up by means of external resistors. — Editor.)

THE CIRCUIT

The complete circuit diagram of the sound activated switch appears in Fig. 1. The input stage is based upon one of the four amplifiers contained in the CA3401E i.c., and this has R_1 as the bias resistor for the non-inverting input whilst R_2 and R_3 form a negative feedback loop. The latter resistors set the voltage gain at a little under 400 times (52dB) and the input impedance at 12k Ω .

Normally a crystal microphone would need to be matched into a very high impedance, say something in the region of 1 to 2M Ω , in order to obtain a good bass response. Here, however, the bass response is of little importance and a comparatively low input impedance is quite satisfactory. No input d.c. blocking capacitor is required since a crystal microphone has an extremely high resistance and it does not, therefore, interfere with the biasing of the amplifier.

C_2 is required to provide a degree of high frequency roll-off. Without this component the circuit would be likely to develop instability due to stray high frequency feedback.

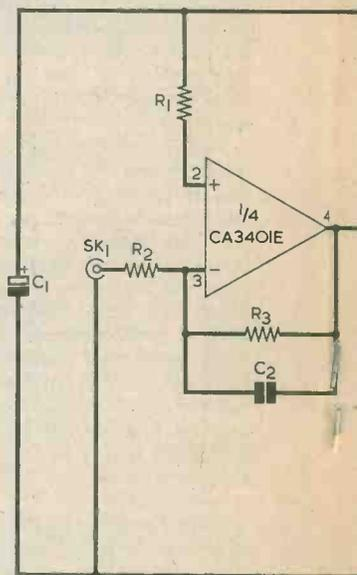

Fig. 1. The circuit of the sound activated switch which energises, with its

SOUND ACTIVATED SWITCH



Poss

Incorporates
readily assembled
switched on
picked up b

used in a number
communications
ing (voice operated
employed in burglar
e very interesting

t of this article is a
be triggered by an
um range of about
01E quad Norton
e component which
device is employed
ystal microphone,
egular readers will
Using Quad Nor-
e which described
and the manner in
bias can be set up
Editor.)

of the sound ac-
The input stage is
rs contained in the
e bias resistor for
2 and R3 form a
r resistors set the
es (52dB) and the

would need to be
ce, say something
r to obtain a good
ass response is of
ely low input im-
input d.c. blocking
al microphone has
nd it does not,
g of the amplifier.
of high frequency
e circuit would be
tray high frequen-

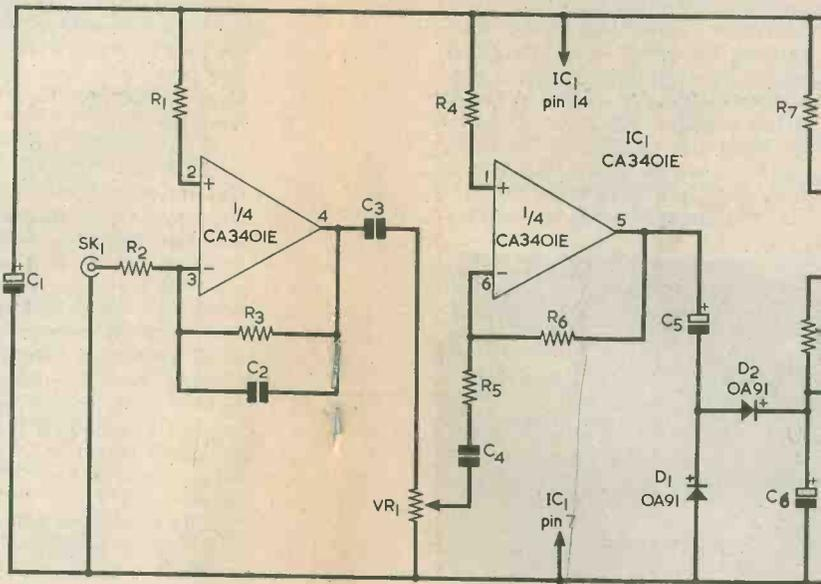
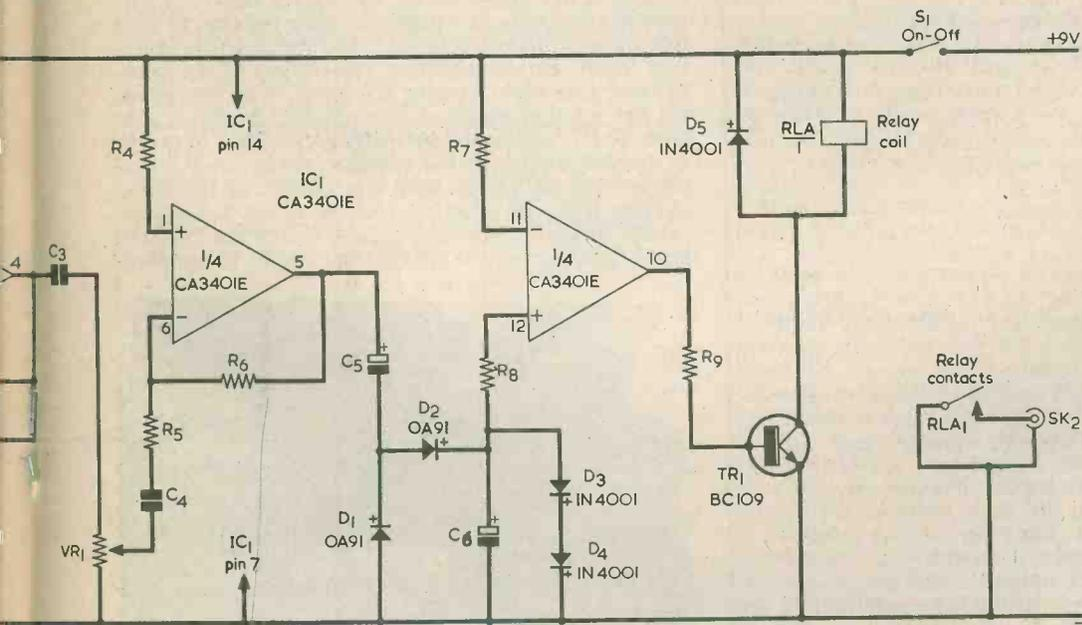

Fig. 1. The circuit of the sound activated switch. A crystal microphone energises, with its contacts closing, when a sound of sufficient

ACTIVATED SWITCH

Possible application as a burglar alarm

Incorporating a modern quad Norton amplifier i.c., this readily assembled unit causes an external circuit to be switched on whenever sound above a pre-determined level is picked up by a crystal microphone.



the sound activated switch. A crystal microphone is plugged into SK1 and the relay with its contacts closing, when a sound of sufficient amplitude is picked up

COMPONENTS

Resistors

(All fixed values $\frac{1}{4}$ watt 5%)

- R1 10M Ω
- R2 12k Ω
- R3 4.7M Ω
- R4 2.2M Ω
- R5 5.6k Ω
- R6 1.2M Ω
- R7 2.2M Ω
- R8 22k Ω
- R9 10k Ω
- VR1 5k Ω potentiometer, log

Capacitors

- C1 1,000 μ F electrolytic, 10 V. Wkg.
- C2 82pF ceramic
- C3 0.1 μ F type C280 (Mullard)
- C4 0.1 μ F type C280 (Mullard)
- C5 10 μ F electrolytic, 10 V. Wkg.
- C6 50 μ F electrolytic, 6 V. Wkg.

Semiconductors

- IC1 CA3401E
- TR1 BC109
- D1 0A91
- D2 0A91
- D3 1N4001
- D4 1N4001
- D5 1N4001

Switch

- S1 s.p.s.t. toggle

Sockets

- SK1 3.5mm. jack socket
- SK2 2.5mm. jack socket

Relay

- RLA1 relay with normally open contact set (see text)

Miscellaneous

- Crystal microphone with screened lead (see text)
- Verobox type 75-1238D
- Veroboard, 0.1in. matrix
- 3.5mm. screened jack plug
- 2.5mm. jack plug
- Control knob
- 9 volt battery type PP6 (Ever ready)
- Battery connector
- Aluminium sheet (for relay bracket)
- Screened wire

The output of the input stage is fed to a volume control type of sensitivity control, VR1, via d.c. blocking capacitor C3. It is important that this control be incorporated in the circuit as the maximum sensitivity of the unit is quite high, and in most applications it will be necessary to employ reduced sensitivity in order to avoid spurious triggering.

A second amplifier is fed from the slider of the sensitivity control, and the voltage gain and input impedance of this stage are set at approximately 200 times (46dB) and 5.6k Ω respectively by means of R5 and R6.

The output of this second amplifier is fed to a rectifying and smoothing network which incorporates D1, D2, C5 and C6. A third Norton amplifier is used as a current comparator, and it has its inverting input fed from the positive supply rail via R7. Its non-inverting input is fed from the output of the rectifier and smoothing network by way of R8.

When no input signal is applied to the circuit there is no significant voltage developed across C6, and so virtually no current flows into the non-inverting input of the current comparator. Obviously a small current flows through R7 into the inverting input, and the output of the comparator is therefore low.

TR1 is a high gain common emitter amplifier and it has a relay coil as its collector load. The base of TR1 is fed from the output of the current comparator by way of R9, and so with the output of the comparator in the low state TR1 is cut off and the relay is de-energised. If, however, the output of the comparator should go high then TR1 will turn on and the relay will be energised. D5 is the usual protective diode which eliminates the high reverse voltage which would otherwise be developed across the relay coil when the relay de-energises.

When an input signal is applied to the unit a voltage is developed across C6, and if this is of sufficient amplitude it causes a higher current to flow into the non-inverting input than flows into the inverting input. In consequence, the output of the comparator goes high, causing the relay to be energised. R8 has a value which is only one-hundredth of that given to R7, and so theoretically only a little in excess of one-hundredth of the supply voltage needs to be present across C6 to send the output of the comparator high. In practice, though, about 0.5 volt is needed at the non-inverting input before the relevant input transistor of the comparator begins to conduct.

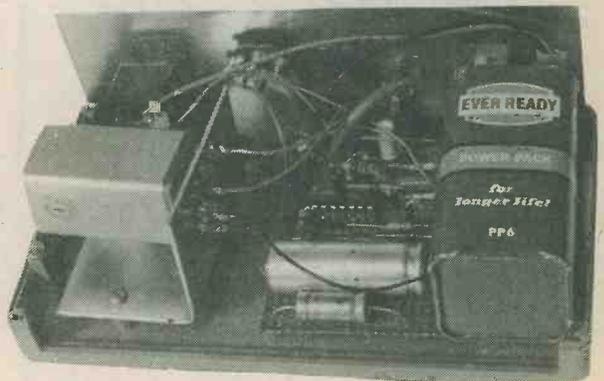

Despite its small size there is ample room inside the case for the various sections of the switch

Thus, about 0.6 volt is required across C6 before the relay becomes energised. Due to the high overall gain of the unit only a very small input signal level is needed to produce such a voltage.

The circuit has a form of time hysteresis, insofar that the relay energises at virtually the instant an input signal of sufficient amplitude is applied, whereas once this signal ceases there is a slight delay before the relay releases. This delay is controlled by C6, and with the specified value a delay of about 1 second is produced. The effect is beneficial since it prevents the relay from de-energising during any brief pauses, as occur during normal speech. The length of the delay is roughly proportional to the value of C6, and it could if desired be altered to suit individual requirements by adjusting the value of this component.

One problem that occurred with this circuit originally was that a very strong input signal (such as is produced if the microphone is accidentally knocked) caused a relatively high voltage to be produced across C6, resulting in a rather long delay. D3 and D4 were therefore included in the circuit, and their purpose is to act as a low voltage clipper which limits the voltage across C6 to a little more than 1 volt. The result is a much more consistent delay.

S1 is the on-off switch and C1 is the supply decoupling capacitor. The relay has a normally open set of contacts which connect to a socket, SK2, on the front panel of the unit. Only three of the amplifiers in the CA3401E are employed and no connections are made to the pins of the remaining amplifier.

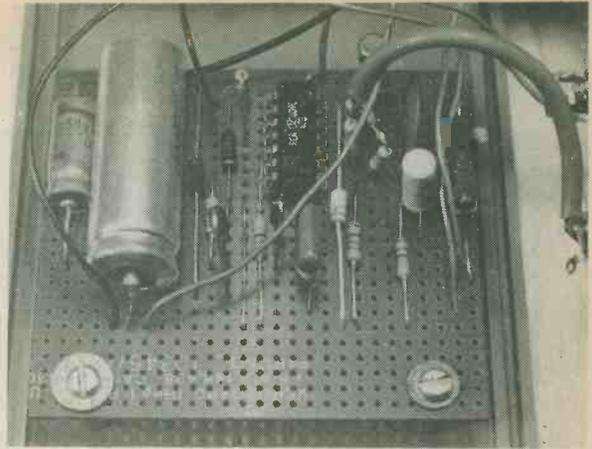

A close-up shot of the Veroboard panel

connects to the Veroboard panel; its free end is later soldered direct to the inner conductor of a screened wire which connects it to SK1. The input of the circuit is very sensitive, and this arrangement minimises stray pick-up and feedback.

RELAY

The circuit will function with any relay which has a nominal operating voltage of 6 volts and a coil resistance of about 300 Ω or more. However, as there is not a great deal of space available inside the case it is necessary for the relay to be a modern type of small size.

It is also advisable to use a fairly quiet type as otherwise problems with acoustic feedback may occur. What happens here is that as the relay de-energises it makes a sound which is picked up by the microphone. This triggers the unit and causes the relay to operate once again. Shortly afterwards the relay releases and once again makes a sound which triggers the unit. The circuit thus continually oscillates in this manner. It is because of this feedback that it is necessary to use an external microphone.

A relay from the author's junk box was used in the prototype but the circuit was also checked out with two standard relays, both of which proved to be perfectly satisfactory. One relay was a Miniature Open P.C. Relay with 410 Ω coil whilst the other was a Reed Relay rated at 6-9 volts with a 700 Ω coil. These two relays are available from Doram Electronics. The reed relay is excellent for use in this type of circuit because it is virtually silent in operation and has a comparatively modest current consumption. However, its contacts have a low current rating, of 200mA maximum.

The relay is mounted on the right hand side of the case, and it will be necessary to construct a simple aluminium bracket to enable it to be secured with a self-tapping screw to one of the mounting pillars on the base of the case. The bracket is made to suit the particular relay used.

The component panel is mounted on the two mounting pillars at the left hand side of the case, but it is first wired up to the rest of the unit. All this wiring is

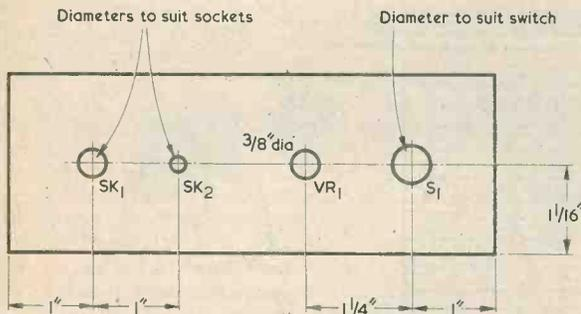

Fig. 2. Drilling dimensions for the front panel of the unit

VEROBOARD PANEL

The unit is built into a Verobox type 75-1238D, this having dimensions of 154 by 85 by 60mm. Details of the front panel layout are shown in Fig. 2.

Most of the circuit is wired up on a 0.1in. pitch Veroboard having 27 holes by 24 copper strips, and this panel is illustrated in Fig. 3. Start by cutting out a panel of the correct size with a small hacksaw and then drill the two mounting holes to take the self-tapping screws provided with the box. Next, make the seven breaks in the copper strips with a Vero spot face cutter or a small twist drill held in the hand.

The components and link wires are then soldered in place with the semiconductor devices being left until last. Care should be exercised when connecting D1 and D2 as these are germanium types and can be damaged by excessive heat. Only one lead-out of R2

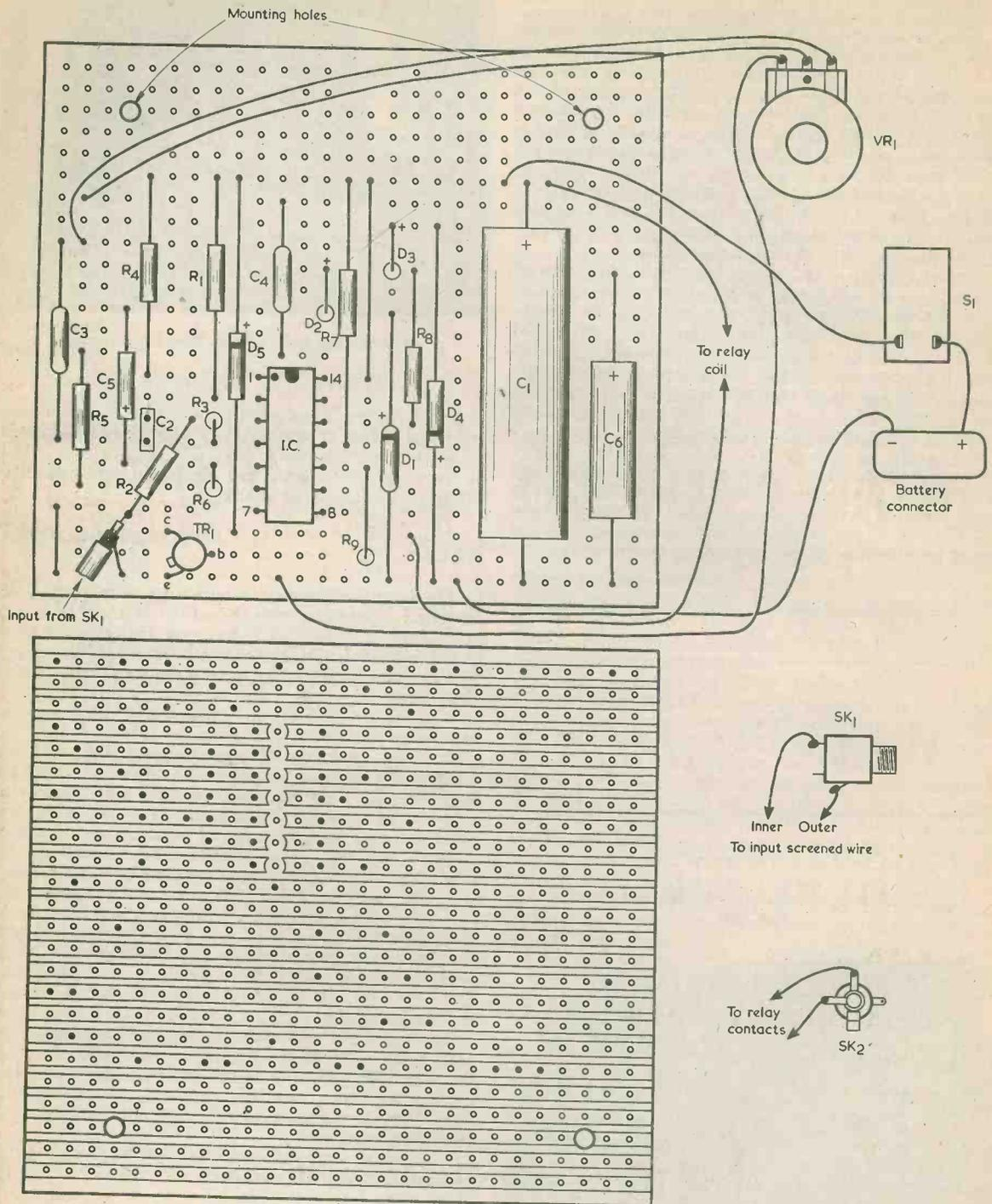

Fig. 3. Most of the components are assembled on a Veroboard panel, as shown here. Also illustrated are the connections to the external components

shown in Fig. 3. The front panel is made common with the negative supply rail by way of the metal mounting bush and nut of SK1 and the braiding of the screened wire which connects to it. Note that SK1 is a 3.5mm. socket whilst SK2 is a 2.5mm. type.

There is space for the PP6 battery to fit at the extreme left hand side of the case, but it will be obstructed by the two mounting pillars on the top section of the case unless these are cut down slightly. This is easily achieved by means of a drill of about 10mm. diameter. Thin plastic foam may be used to ensure that the battery case does not make contact with components and wiring on the Veroboard panel.

The current consumption of the unit is about 4mA when the relay is de-energised, this increasing by the relay coil energising current when the relay operates.

A crystal microphone is plugged into SK1, and the microphone lead should not be longer than about 2 metres. It is absolutely essential that this lead be screened. The 3.5mm. jack plug to which it connects must be a screened type, also.

An inexpensive microphone of the type which has a rectangular moulded case will give best results.

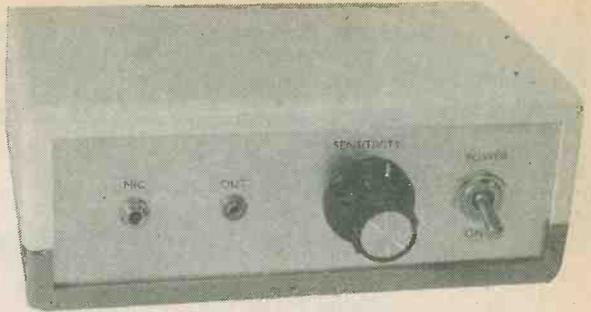

Another view of the sound activated switch. The panel legends are taken from "Panel-Signs," Set No. 4

Microphones of this type appear to have a much higher output than the more expensive "stick-type" models and, of course, quality is of no importance whatsoever in the present application. Even a crystal microphone insert will be found suitable. ■

IN NEXT MONTH'S

RADIO & ELECTRONICS CONSTRUCTOR

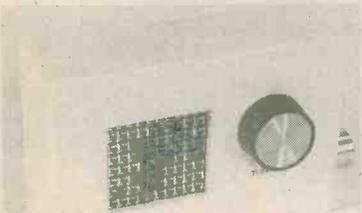

MEDIUM WAVE POCKET RADIO

A SELF-CONTAINED RADIO INCORPORATING
2 INTEGRATED CIRCUITS—THE ZN414 and
LM380N

- ★ Covers the standard medium wave band
- ★ No alignment required

L.E.D. VU METER

AN INGENUOUS DESIGN
INCORPORATING
2 QUAD NORTON AMPLIFIER
I.C.'s TO CONTROL 7 L.E.D.'s

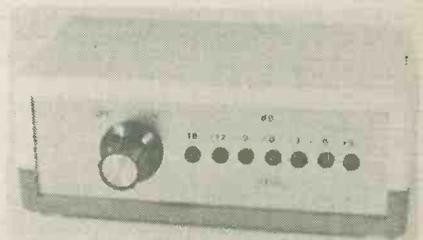

SPECIAL BLOB-A-JOB SERIES
No. 3 12-Note Tone Generator

MANY OTHER PRACTICAL ARTICLES

ORDER NOW!

ON SALE 1st AUGUST

PRICE 40p

SHORT WAVE NEWS

FOR DX LISTENERS

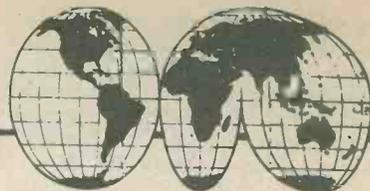

By Frank A. Baldwin

Times = GMT

Frequencies = kHz

Clandestine transmissions have always been of interest to the writer and to many short wave listeners and we have drawn the attention of operators to these programmes on several occasions in the past. Some of the latest information on these stations is listed below.

The "Voice of Lebanon" is a pro-Phalangist transmitter operating on 6850 from 0530 to 0930, 1100 to 1530 and from 1715 to 2030 in Arabic; from 1530 to 1600 in Armenian and from 1600 to 1715 in English and in French. Identification is "This is the Voice of Lebanon, the Voice of Freedom and Dignity" (in Arabic "Huna Sawt Lubnan, Sawt al-Hurriyah wa al-Karamah").

"Voice of the Malayan Revolution" (in Malay "Ini-lah Suara Revolusi Malaya") is a pro-communist clandestine thought to be located near Changsha in the Hunan Province of China. Programme languages are English, Tamil, Malay and Standard Chinese and are radiated from 0430 through to 0005 sign-off on 11830 and on 15790. The programmes in English are from 0930 to 1015, 1450 to 1530.

"Radio Echo of Hope" operates on 6348 from 0200 to 0505; 0900 to 1205 and from 1230 to 1535 in Korean to North Korea. This is probably the former "Voice of Hope" which used this channel in 1973-4 and thought to be a counter-blast to the pro-communist North Korean "Voice of the Revolutionary Party for Reunification" transmitter which is on 4120 and 4552 in English and Korean from 0300 to 2330 at various time periods throughout the day, (try 4552 from 2300 to 2330 when they are in English to S. Korea).

Or you can listen to clandestine programmes from back to front — seriously folks — more next month!

CURRENT SCHEDULES

● MAURITIUS

The Mauritius Broadcasting Corporation, Forest Side (Port Louis), operates a Domestic Service on 4850 from 1300 to 1830 (1900 on Saturdays) and on 9710 from 0200 until 1300. Programmes are in English, French, Chinese and Indian languages, there being English newscasts at 0400 to 0415 and from 1800 to 1810.

● CYPRUS

A Commercial Service from "Radio Bayrak" in the Turkish Federated State of Cyprus is radiated on 6140 (variable) from 0424 to 2100. Programmes are in English, Turkish and Greek, the English language programmes being from 1215 to 1245 and from 1730 to 1800.

● EGYPT

"Radio Cairo" has an Overseas Service in which an English programme is directed to Europe from 2200 to 2315 on 9805. Some other programmes in English are as follows — to South Asia from 1315 to 1445 on 17920; to Africa in the "Voice of Africa" transmissions from 1715 to 1845 on 15255 and from 2030 to 2200 on 11790.

● NIGERIA

A Domestic Service from Lagos (National Programme) is broadcast from 0430 to 1000 and from 1500 to 2305 on 4990 and from 0700 to 1630 on 7255, most of the programmes are in English.

● ZAIRE

"The Voice of Zaire", Kinshasha, presents a Domestic Service, mostly in French, on a 24-hour basis on 7115, 15245 and on 15350.

● BELGIUM

An External Service from Brussels, in English to Africa, is to be heard daily from 1615 to 1700 on 9745 and on 11940.

AROUND THE DIAL

● ISRAEL — 1

Jerusalem on a measured 7412 at 2000, station identification, YL with a newscast in English in the programme scheduled from 2000 to 2030. Also logged in parallel on 9090, 9425, 9815 and on 15512.

● BULGARIA

Radio Sofia on 9700 at 1930, OM with a newscast in English after station identification. This is the programme in English for the U.K. and Eire, scheduled from 1930 to 2000 on this channel and in parallel on 6070.

● GREECE

"Voice of Greece", Athens, on 9530 at 1920, YL with the world news in English after station identification in the newscast scheduled from 1920 to 1930 on this channel and in parallel on 6140, 7215 and on 9675.

● NETHERLANDS

"Radio Netherlands," Hilversum, on the unlisted channel 9895 at 1515, OM with the news headlines in English, presumably in the transmission scheduled from 1400 to 1520 in English to Europe, the Far East and South and South East Asia.

● **INDIA**

AIR Delhi on 9525 at 1927, YL with a talk in English on local religious ceremonies. This is the scheduled General Overseas Service in English directed to the U.K., East Africa and West Europe on this frequency and also in parallel on 7225, 9730, 11620 and on 15080 from 1745 to 1945.

● **EGYPT**

Cairo on 15475 at 1429, OM with Arabic songs, local-style music in the "Voice of the Arabs" programme intended for the Middle East, North and Central Africa and Southern Europe scheduled on this channel from 0800 to 1400 and from 1500 to 1900.

● **CHINA**

Radio Peking on 7935 at 2058, YL with a song in Chinese in the 1st Domestic Service scheduled from 1041 to 1735 and from 2000 to 2330 at this point of the dial.

Radio Peking on 4460 at 1958, interval signal ("East is Red") in the 1st Domestic Service scheduled from 0931 to 1735 and from 2000 to 0020.

Radio Peking on 9940 at 1505, YL with a newscast in Hindi directed to South Asia from 1500 to 1600 on this channel.

Radio Peking on 9860 at 1510, OM with a newscast in English beamed to South Asia, this being part of the English transmission directed to that area from 1400 to 1500 and also in parallel on 3270, 3985, 7315, 7455, 7470 and on 11650.

Radio Peking on 4800 at 2014, Chinese orchestral music in the 1st Domestic Service scheduled from 2000 to 0100.

● **NIGERIA**

Kaduna on 3396 at 1730, OM in English with identification and local news. The schedule is from 0430 to 0705 and from 1630 to 2305.

Lagos on 4990 at 2032, OM with a talk in English in the National Programme scheduled from 0430 to 1000 and from 1500 to 2305, the power being 10kW.

● **PAKISTAN**

"Radio Pakistan", Karachi, on 9460 at 1445, local music, OM with songs in Urdu in the programme of that language directed to the Persian Gulf and the Middle East from 1330 to 1630, also in parallel on 7290 and 11675.

Quetta on 3240 at 1930, OM with identification after the interval signal. According to the schedule should not be on at this time!

● **IRAN**

"Radio Iran", Tehran, on 15260 at 1350, local-type music in the Domestic Service radiated to Western Europe and Eastern USA scheduled from 0700 to 1600 on this frequency and in parallel on 15085.

● **VIETNAM**

Hanoi on a measured 15008.5 at 1840, OM with a talk in English about internal air travel in Vietnam, in the programme scheduled from 1800 to 1900.

● **NORTH KOREA**

"Radio Pyongyang", on 6600 at 2019, choral music, OM in Korean in the Domestic Service, scheduled from 2000 to 0830 and from 1500 to 1800.

● **SENEGAL**

Dakar on a measured 4891 at 0613, OM with chants from the Holy Qur'an in the Home Service, scheduled from 0600 to 0800 and from 1800 to 2400, the power being 25kW.

● **GUINEA**

Conakry on 4910 at 0629, OM's with a discussion in vernacular after identification. The schedule shows them to be on the air from 1230 to 0830 continuous and the power is 18kW.

● **UGANDA**

Kampala on a measured 4976 at 2030, African chants and drums in typical style in the Regional Programme scheduled from 0300 to 0545 and from 1400 to 2105 the power being 7.5kW.

● **ZAMBIA**

Lusaka on a measured 4911.5 at 1912, local music and songs, YL announcer in the Home Service radiated on this channel from 2055 to 0530 and from 1400 to 2105 (Sundays until 2005) the power being 50kW.

● **TANZANIA**

Dar-es-Salaam on 5050 at 1857, typical local African music in rhythmic style in the Swahili Commercial Service scheduled from 0300 to 0500 and from 1400 to 2015, the power is 10kW.

● **ISRAEL — 2**

Jerusalem on a measured 12077 at 1310, YL announcer in Hebrew, classical music in the Domestic Service Network B directed to Western Europe and North America scheduled from 0600 to 2000 on this channel.

Jerusalem on 9815 at 2006, YL with current affairs programme in English directed to Western Europe, North America and Africa, scheduled from 2000 to 2030.

● **BRAZIL**

Radio Difusora de Macapa, on 4915 at 0255, OM with identification, commercials, local pops on records. The schedule is from 0800 to 0300, the power is 2.5kW and sometimes identifies as "Aqui Difusora".

Radio Religio, Rio de Janeiro, OM with a talk in Portuguese, continually intruding time pips (a hallmark of this station). Schedule is from 0800 to 0300 (off the air on Tuesdays and Fridays from 2200 to 2330), the power is 5kW.

Radio Borborema, Campina, on a measured 5024 at 0345, light orchestral music, OM announcer in Portuguese, schedule is from 0830 to around 0420. Not only does the sign-off time vary but so does the frequency, anything from 5020 to 5025. Oh yes, I nearly forgot, sometimes identifies as "A Princesa do Sul".

● **COLOMBIA**

Radio Guatapuri, Valledupar, on a measured 4816 at 0430, OM with identification, announcements, Latin American music in typical style. The schedule is from 0930 to 0600 but sometimes known to sign-off at 0500 and is even listed on 4915 although it often "wandered" to 4917 but has been on the measured channel (more or less!) for some weeks at the time of writing. Where next?

UNDERSTANDING TELEVISION



by

J. R. DAVIES

Over 500 pages
300 diagrams

- Principles of 405 line reception
- Principles of 625 line reception
- Nature of the television signal
- Receiver tuner units
- A.F. and video amplifiers
- Deflector coil assemblies
- Automatic gain and contrast control
- Receiver aerials
- The cathode ray tube
- Receiver i.f. amplifiers
- Vertical and horizontal timebases
- Synchronising
- Power supply circuits
- **COLOUR TELEVISION** – 80 page section deals comprehensively with this subject

£3.25 P. & P. 60p.

To: DATA PUBLICATIONS Ltd., 57 Maida Vale London W9

Please supply.....copy(ies) of "Understanding Television" Data Book No. 17. I enclose cheque/crossed postal order for

Name

Address

BLOCK LETTERS PLEASE

CONSTRUCTOR'S CROSSWORD

Compiled by J. R. Davies

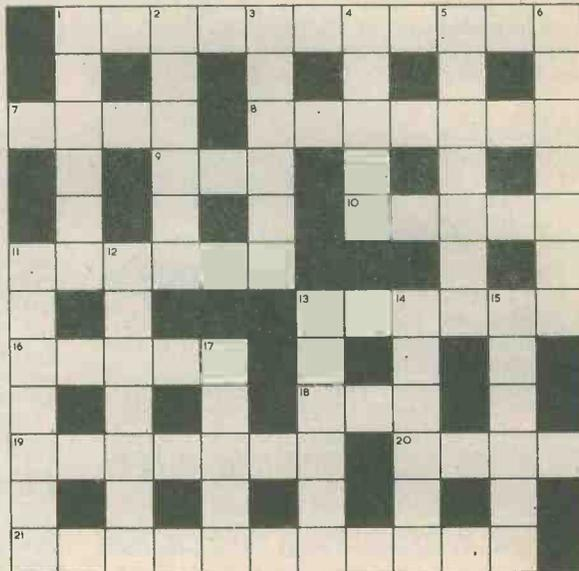

CLUES ACROSS

1. It can pace a.c. as well as pass it. (11)
7. Unpleasant-sounding unit of data flow. (4)
8. Instrument proclaiming itself. (7)
9. A third of a dash. (3)
10. Arm's length. (5)
11. Descriptive of a tuning drive. (6)
13. Middle-aged characteristic of characteristics. (6)
16. A component isolated. (5)
18. Really quite hopeless. (3)
19. Impetuous overloaded tape transducer. (3-4)
20. Appears in the components list. (4)
21. Applies to the colour signal. (11)

CLUES DOWN

1. Electricity possessed by the light brigade? (6)
2. Tracking capacitor. (6)
3. You'll find this cathode in a thermionic tube. (6)
4. 555. (5)
5. Simply an inverter. (3, 4)
6. Grounded in the United States. (7)
11. Vivid circuit symbols. (7)
12. Compliant device with hermaphroditic properties. (7)
13. This death was experienced by point-contact transistors. (6)
14. Angular dimension. (6)
15. What could pass through 8 across. (6)
17. Hot unit of the Royal Marines? (5)

(Solution on page 768)

SIMPLE QUADRAPHONIC AMPLIFIER

Part 2

By R. A. Penfold

Continuing the short series on this quadrasonic amplifier, details are given this month of the construction of the power supply, the tone control circuit and the four power amplifiers. Also introduced is the circuit of the magnetic cartridge pre-amplifier and the SQ decoder.

In the first article in this series we discussed the principles of quadrasonic reproduction then proceeded to constructional details for the present amplifier, commencing with the building of its case. We next dealt with the circuit of the power supply, and we now carry on to the assembly of this section.

POWER SUPPLY CONSTRUCTION

Transformer T1 and reservoir capacitor C1 are mounted on the left hand side of the case, using two woodscrews for each. C1 is mounted by means of its clamp.

All the small power supply components are assembled on a printed circuit board measuring 4 by 2½ in. This is reproduced full size in Fig. 5 so that it can be easily copied. The two mounting holes are intended for M3 metric bolts, but 6BA bolts may alternatively be employed. TR4 is fitted with a small clip-on heatsink which is not shown in the diagram.

The completed board is mounted above the chassis

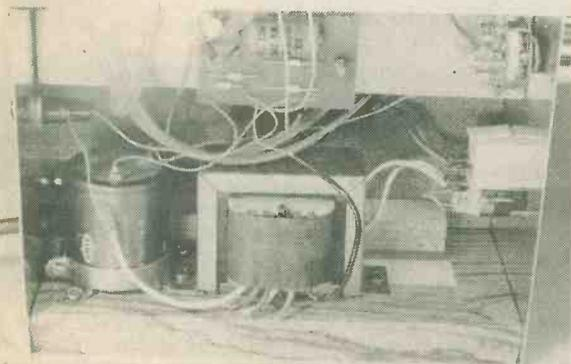

The mains transformer and reservoir capacitor are mounted at the left hand side of the case

at the extreme left hand end. The board end at which rectifiers D1 to D4 appear is that which is nearer the mains transformer. The board may be employed as a template for marking out the mounting holes on the chassis. TR2 is mounted on the rear panel with insulating bushes and mica washer, a solder tag being fitted under one of its securing nuts to provide connection to the collector.

The board is mounted after the external connections have been made to T1 secondary, FS1, C1 and TR2. Leads a little longer than a foot may be soldered to the 20 volt and 12 volt output points. These can be shortened as necessary when they are later connected to the pre-amplifier and decoder board. Make certain that their ends cannot accidentally short-circuit to chassis.

The board is then mounted on the chassis, employing metal spacers to ensure that its underside is well clear of the chassis surface. The mounting bolt heads are below the chassis. The metal spacers also provide the chassis connection to the printed board. For complete protection against short-circuits between the board underside and chassis a piece of thin s.r.b.p. having the same outline as the board could be secured by the mounting screws immediately above the chassis, but this was not considered necessary with the prototype.

The mains input wiring to S1, PL1 and T1 primary, and the secondary connection to FS1, may next be completed, following the circuit given in Fig. 4 (published last month). The mains lead should be secured inside the case by a small plastic clip, or similar, screwed to the left hand side of the case. The mains earth wire is connected to a solder tag fitted at any convenient chassis point, such as under one of the mounting nuts for SK1.

After the wiring has been thoroughly checked, the mains can be applied and the power supply section tested. A testmeter can then be used to check that the three output voltages are provided. It should be noted that the voltages specified are approximate only and that quite wide variations from nominal can be given, particularly at the 20 volt and 12 volt outputs.

Fig. 5. The component and copper sides of the boards on which the smaller power supply components are assembled. This is reproduced full size for tracing.

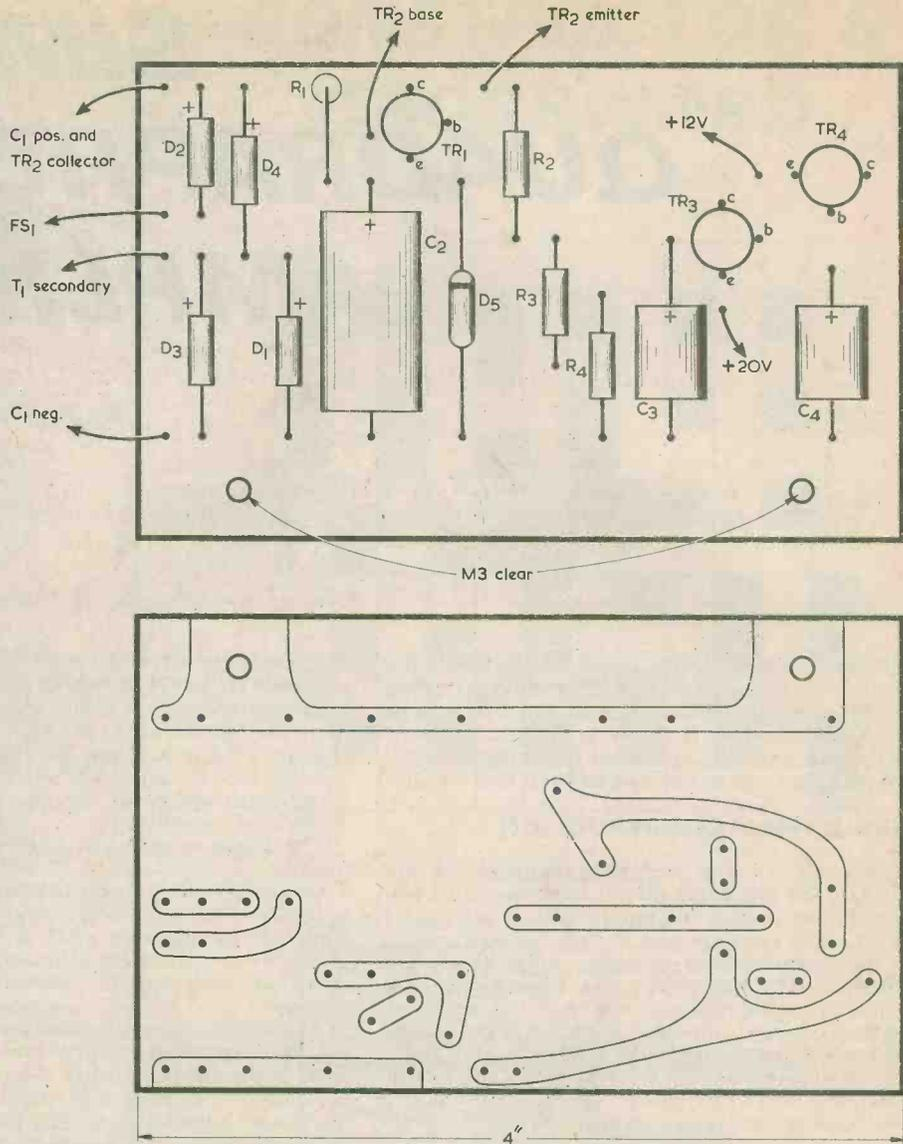

POWER AMPLIFIERS

The circuit of the power amplifiers and tone control networks is illustrated in Fig. 6. These are shown for one channel only, the four channels being identical.

A Texas SN76023N i.c. forms the basis of the power amplifier for each channel, and this device will not be considered in detail as it has been covered by several previous articles in this journal.

When operated from a 26 volt supply the SN76023N is capable of offering about 5 watts r.m.s. before clipping of the output waveform commences. It has an integral aluminium heatsink and no other heatsinking is required. It provides low levels of noise and distortion.

C13, C16, C17, C18 and R12 are needed to maintain good stability. The ratio of R11 to R10 sets the voltage gain of the amplifier, and in this instance the gain is 270 times. R8 and R9 bias the non-inverting input of the i.c. and C14 provides supply decoupling

of this bias voltage. C12 and C19 are the input and output d.c. blocking capacitors respectively, and C20 is a supply decoupling capacitor.

The channel shown in Fig. 6 is one of the front channels, both of which have the single capacitor C6 as supply bypass. The two rear channels have the single capacitor C5 as supply bypass. S2 is the 2 Channel - 4 Channel switch and, when it is closed, provides power to all four power amplifiers. When it is opened, power is removed from the rear channel amplifiers and only the two front channels are in use. There is a current surge in the contacts of S2 when it closes, this being due to the sudden charging of C5, and the current is largely limited by the internal impedances of C5 and C6. The author employed a normal rotary switch here and this withstands the current surge satisfactorily in practice. However, it is appreciated that the use of a rotary toggle switch capable of handling mains voltages and currents would offer a wider current handling ability, and it is

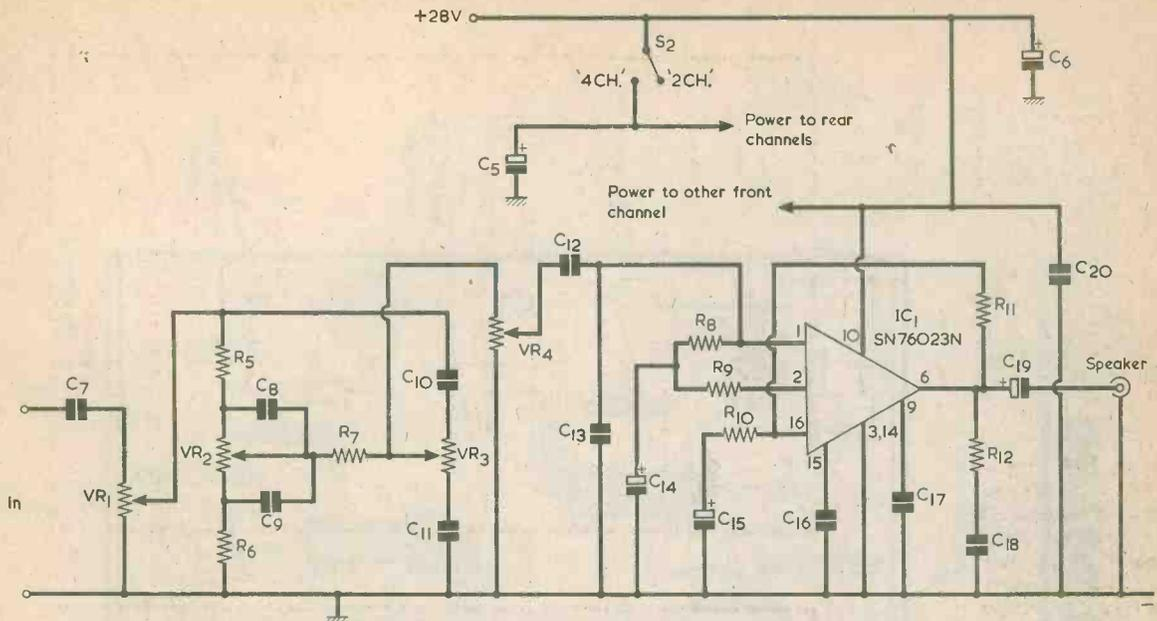

Fig. 6. The circuit of one of the front channel power amplifiers. The other power amplifiers are identical. Power is applied to the rear amplifiers by way of S2.

for this reason that such a switch is specified for S2.

There are two volume controls for each channel, VR1 and VR4. VR1 is the main volume control and is the 4-gang component which controls all four channels simultaneously. VR4 consists of a separate component for each channel, and these take the place of the conventional balance control used on two channel equipment.

The tone control circuit is of quite normal design and it provides bass and treble lift and cut. VR2 is the bass control and VR3 is the treble control. The two front channel VR2 controls are provided by a single 2-gang potentiometer, and the two rear channel VR2 controls are given by another single 2-gang potentiometer. The same arrangement is employed for the VR3 controls. The tone control circuit is a passive network, and there is a considerable loss between its input and output. However, the sensitivity at the inputs of the power amplifiers is quite high, with less than 30mV being needed for maximum output. The excess of gain here compensates for the losses in the tone controls.

As was just mentioned, separate bass and treble controls are used for the front and rear channels. This is desirable, as the front and rear channel speakers are often mounted at different heights, and this can result in one set of speakers seeming to have a deficiency of bass and/or treble. Using separate tone controls for each set of speakers enables this situation to be catered for.

The tone control potentiometers in this circuit are specified as log rather than linear, as this provides a flat frequency response at the central settings.

The arrangement chosen for volume, tone and balance controls would seem to be the standard approach used on most commercial quadrasonic amplifiers and tuner-amplifiers. The power amplifier outputs may work into 8Ω speakers or, with a reduction in power, into 15Ω speakers.

POWER AMPLIFIER BOARD

Details of the power amplifier printed circuit board are shown in Fig. 7. Again, this diagram is reproduced actual size so that the copper pattern can be easily traced.

After the board has been prepared for the components it will be found best to solder in the integrated circuits first. The Texas Instruments trademark on the heat sink is at the same corner as pin 1, and identifies this pin.

The completed board is mounted on the underside of the chassis at the extreme right, away from the mains transformer. It is secured with four M3 (or 6BA) bolts and nuts, employing metal spacers, in the same way as was the power supply board. The board takes up its chassis connection via the spacers. However, the board is not finally mounted until all the external connections to the rest of the amplifier have been completed.



The smaller power supply components are assembled on a printed board fitted above the chassis close to the mains transformer

THE POWER AMPLIFIER BOARD

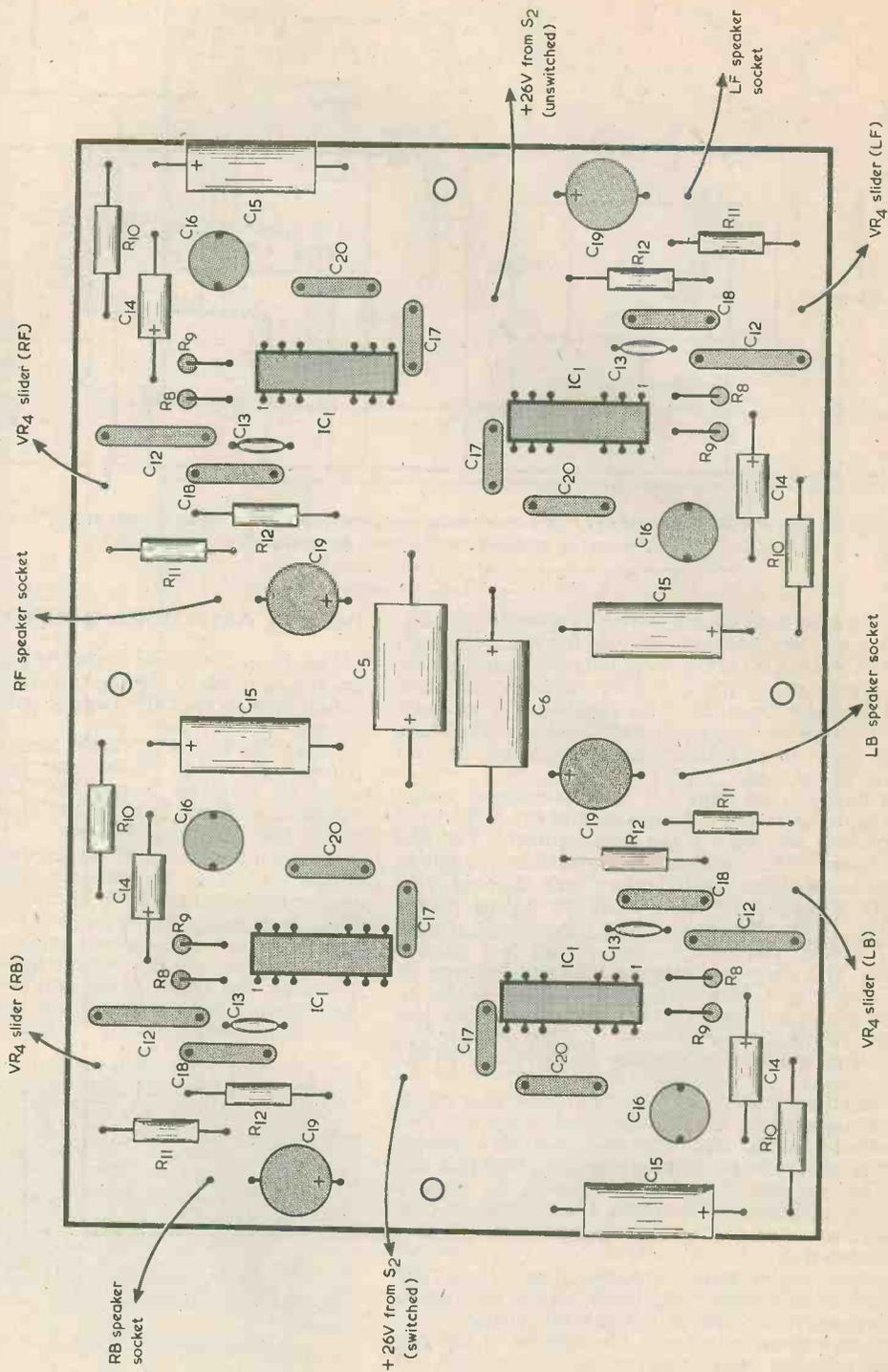

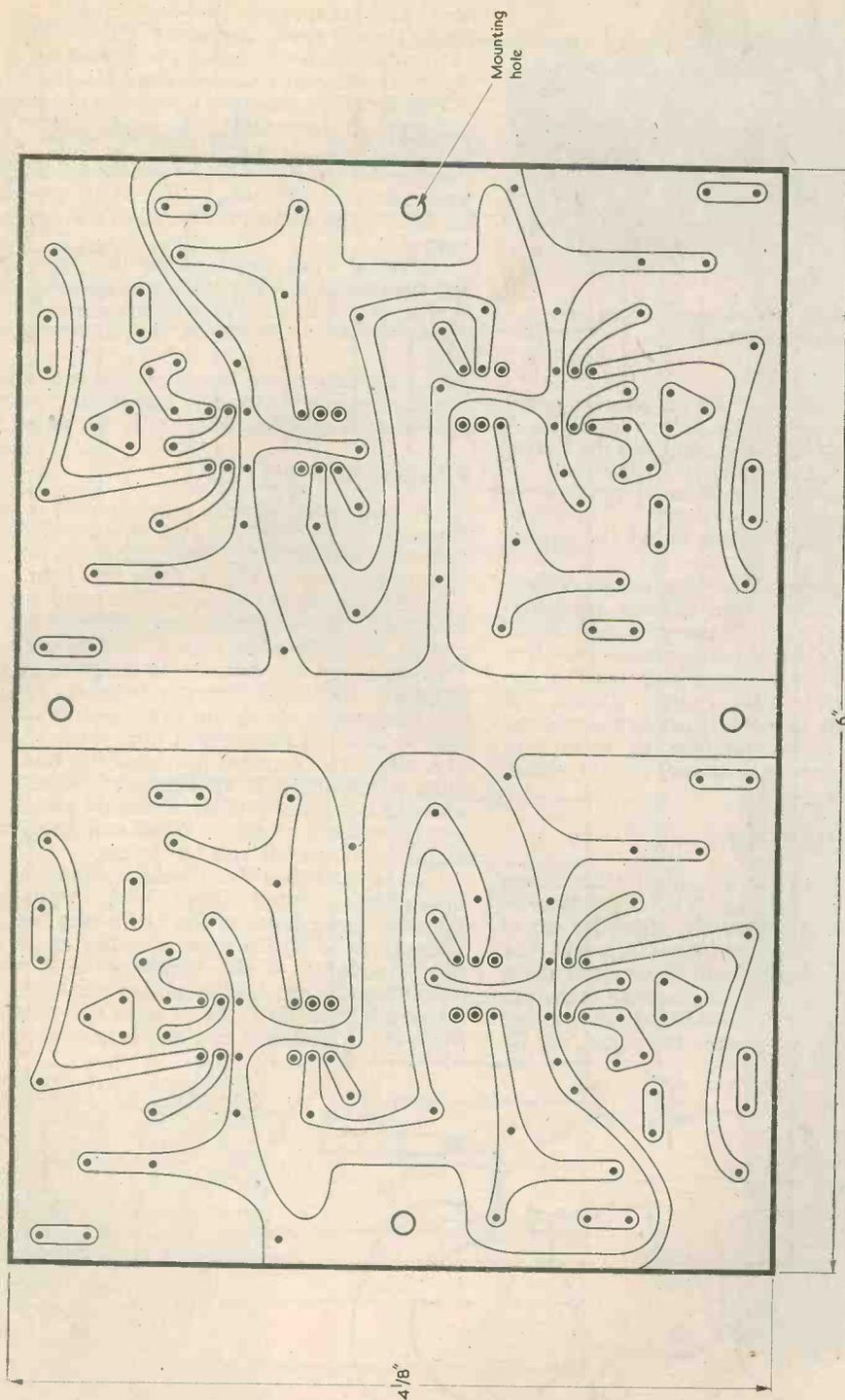
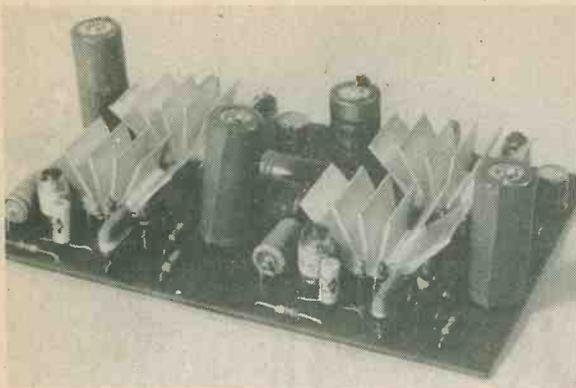

Fig. 7. The power amplifier board. This carries four output power amplifiers and the associated components. The board is also reproduced full size



The board on which are assembled the four power amplifiers

A lead from the emitter of TR2 on the rear panel takes the 26 volt positive supply to one tag of S2. A lead from this same tag takes the supply to the board, as indicated by the lead designated "unswitched" in the diagram. A lead from the other tag of S2 takes the supply via the lead marked "switched". These last two leads may be twisted together above the chassis for neatness.

Four leads take the outputs to the speaker sockets. The earthy connections at these sockets are taken from chassis at the rear panel. Take great care to ensure that there are no short-circuits between the live outputs and chassis. Four screened leads take the inputs to the appropriate VR4 control sliders, the braiding of these leads being earthed at the volume control track tags corresponding to minimum volume. These tags connect to chassis via the solder tags mounted on VR1.

TONE CONTROL WIRING

The components in the tone control circuits are wired on the tags of the VR2 and VR3 controls as illustrated in Fig. 8, which shows the wiring for one of the rear channels below the chassis level. The positions of the potentiometers will be reversed above the chassis for the front channels (because their tags project in the opposite direction) but the connections to the potentiometer tags remains the same, i.e. R5

connects to the track tag corresponding to full clockwise rotation of the spindle of VR2, and C10 connects to the similar track tag of VR3.

The tone control wiring should be kept reasonably neat, and component lead-outs should not be any longer than is really necessary. Otherwise, there will be a noticeable level of mains hum pick-up in the wiring. With the rear channels the resistors R6 connect to chassis at a solder tag under the chassis securing nut which is closer to S3. The capacitors C11 connect to chassis via the metal frame of VR2. Above the chassis, the resistors R6 are connected to chassis by way of the metal frame of VR3, whilst capacitors C11 connect to the earthy track tag of the adjacent VR4 control.

Screened wires are used for the input from VR1 and the output to VR4, the braiding being connected to chassis at VR1 and VR4 respectively. The four C7 capacitors are mounted at the appropriate tags of VR1.

If a suitable mono signal source is available this can be connected to each C7 capacitor in turn, enabling the corresponding channel to be tested.

PRE-AMPLIFIER

The magnetic cartridge pre-amplifier is based on a Motorola MC1339P i.c. and the SQ decoder on a Motorola MC1312PQ. The circuit in which these appear is given in Fig. 9. Only the right hand pre-amplifier circuit is shown, the left hand circuit being the same. The MC1339P contains two identical high quality amplifiers and one is used in each channel. The upper pin numbers in the diagram apply to one amplifier and the lower pin numbers to the other. The amplifiers share the same positive supply pin (pin 1) and the same earth pins (pins 13 and 14).

A magnetic cartridge pre-amplifier has to provide quite a high level of voltage gain, this being in the order of 100 times (40dB). It should also offer an input impedance of about 47k Ω and apply a specific amount of bass lift and treble cut.

C22 is the input d.c. blocking capacitor and R13 biases the i.c. input circuit. With feedback applied the input impedance of the i.c. is very high, and the value given to R13 is approximately equal to the input impedance of the amplifier as a whole. C23 decouples the a.c. feedback that would otherwise be introduced via R13, but it does not affect the d.c. feedback. The result is a stable biasing system.

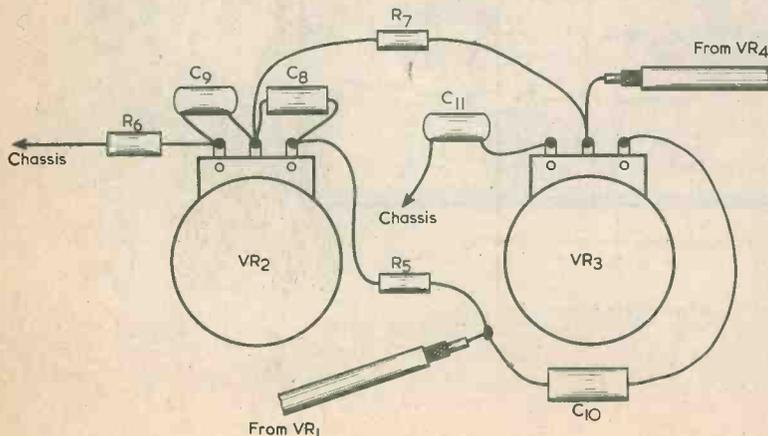

Fig. 8. The wiring around the two tone controls for one of the rear channels

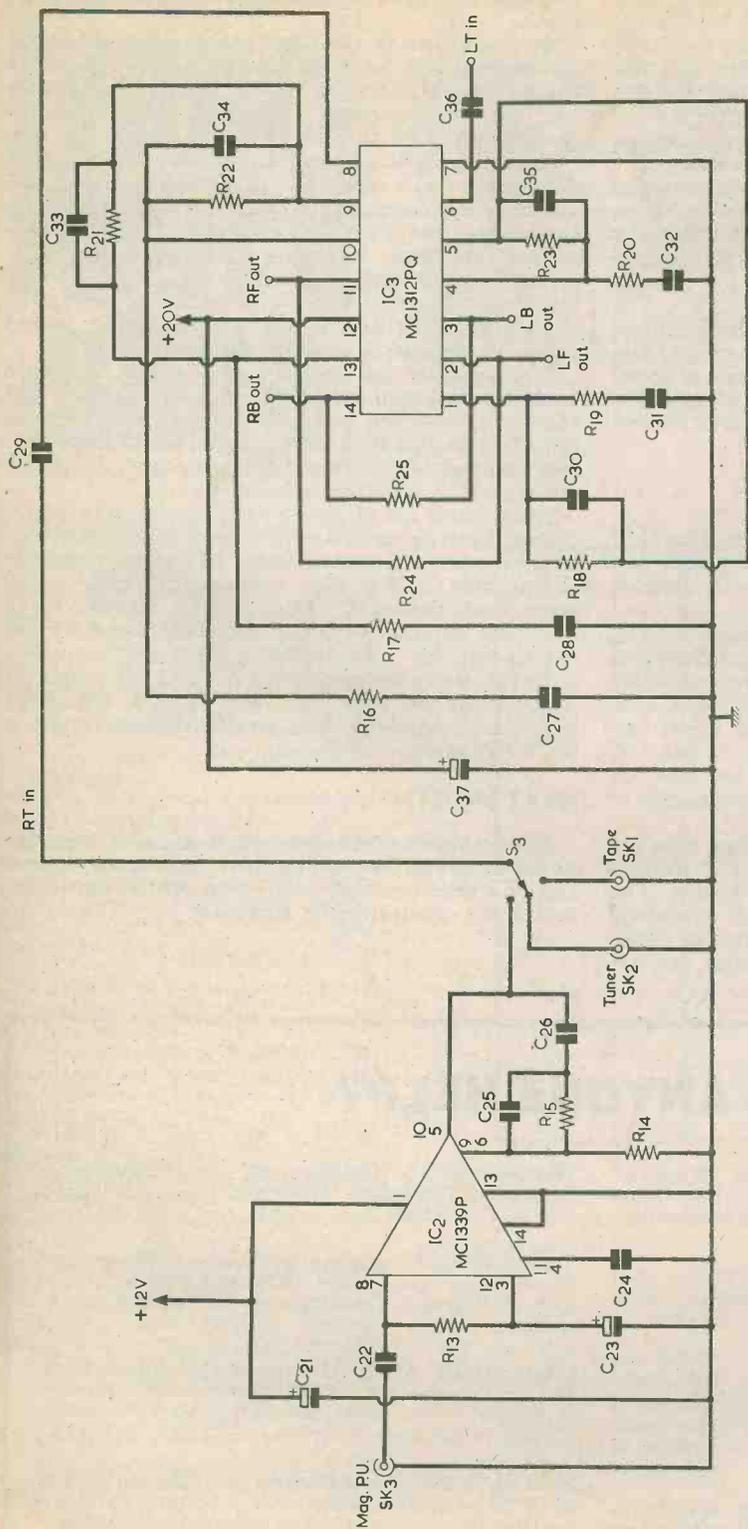
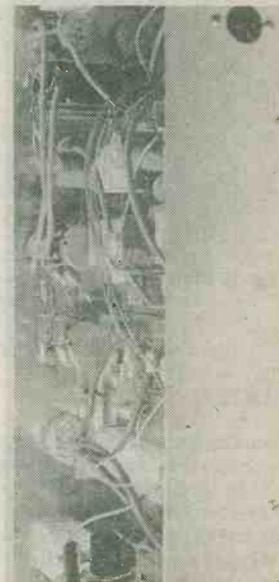

Fig. 9. The circuit of the magnetic cartridge pre-amplifier and the SQ decoder stage



The wiring of the controls above the chassis



Control wiring below the chassis

C24 gives the amplifier a degree of high frequency roll-off outside the audio frequency spectrum, and this prevents instability due to stray r.f. feedback.

R14, R15, C25 and C26 form a negative feedback loop between the output of the amplifier and the emitter of an internal transistor at the input, and the capacitive elements in this network provide the required bass boost and treble attenuation. C21 is the supply decoupling capacitor for both channels.

Apart from 14 transistors, 2 diodes and 16 resistors in the amplifier sections of the i.c., it also incorporates 2 transistors, a resistor and a zener diode in a voltage regulator circuit. A stabilized 7.5 volt supply is available at pin 2, but is not used in the present application.

Each amplifier in the MC1339P has a typical open loop gain of 66dB (63dB minimum) and a typical distortion, at the signal levels encountered here, of about 1% before feedback. The application of negative feedback to the circuit reduces the distortion to only a small fraction of this figure.

DECODER

With its typical total harmonic distortion level of 0.1% and its signal-to-noise ratio of 80dB, the MC1312PQ decoder does not significantly detract from the reproduced sound quality.

The circuit consists basically of two pre-amplifiers, two 90 degree phase shift networks, a differential network and a summing network. The pre-amplifiers give a high input impedance of typically $3M\ \Omega$. This gives a combination of sensitivity and input impedance that is suitable for tape decks, tuners and ceramic cartridges without the need for any additional pre-amplification. The overall voltage gain of the decoder is approximately unity.

Phase shift networks of the Wien bridge type are used, and these produce a phase shift of 90 degrees over a frequency range of 100Hz to 10kHz. The resistive arms of the Wien networks are contained within the i.c., and the RC arms are formed by external components. The only other essential discrete

components are the input d.c. blocking capacitors, C29 and C36, and the supply decoupling capacitor, C37.

As was shown in the Components List (published last month) R16 to R23 in the phase shift networks should have a tolerance of 5%. This is of course an easy matter to arrange. Capacitors C25 to C28 inclusive, and C30 to C35 inclusive, should for best results also have a tolerance of 5%. The 6,800pF (0.0068 μ F) and 8,200pF (0.0082 μ F) values are available in tolerances lower than 5% in polystyrene from a number of suppliers. A series of 5% polycarbonate capacitors, including the values of 0.033 μ F, 0.039 μ F and 0.22 μ F is listed by Maplin Electronic Supplies. Constructors who have access to a capacitance bridge could alternatively select polyester capacitors in these three values.

It is usual to increase the centre front to centre back separation of an SQ decoder by adding blend resistors across the front outputs and the rear outputs. Normally a 10% front channel blend and a 40% rear channel blend is used. This is accomplished by resistors R24 and R25 respectively.

Note that if the magnetic cartridge input is not required it can be converted to a ceramic or crystal cartridge input by simply omitting all the pre-amplifier components. SK3 is then connected directly to the appropriate tags of S3. If this is done, TR4 and C4 in the power supply section are no longer necessary and can be left out.

In Fig. 9 the abbreviations RT and LT stand for Right Total and Left Total, and apply to the stereo inputs to the decoder. The decoder outputs couple to the C7 capacitors of Fig. 6.

NEXT MONTH

Next month's concluding article will give constructional details of the pre-amplifier and decoder board, and will then continue with notes on the use of the completed quadraphonic amplifier.

(To be concluded)

CAN ANYONE HELP?

McMurdo Silver Valve Voltmeter, "Vomax" Model 900 — S. G. Robinson, "Repton", Batt House Road, Stocksfield, Northumberland — Any information, data or diagrams required.

Cossor Oscilloscope, Model 1052 — A. Walker, Pool Hayes Evening Class (Radio), Willenhall, West Midlands — Service Manual, Wiring Diagram or Photostats required, borrow or purchase.

Trio 9R 59DE Communications Receiver Modifications March and April 1971 issues of 'Radio Constructor' — G. Wilson, 65A Gypsy Lane, Nunthorpe, Middlesbrough, Cleveland — Articles or issues to purchase.

Mashpriborintorg All Wave Band Portable Transistor — A. J. Bromley, 25 Wapshott Road, Staines, Middlesex — Service chart or any information.

Heathkit 10-18 μ Oscilloscope — J. M. Pascoe, 37 Kingsmead, Biggin Hill, Westerham, Kent — Manual to borrow or purchase.

Transistorised Oscilloscope 'Radio & Electronics Constructor' December 1972 and January 1973 — L. A. Pearce, 2 The Ridgeway, Fleetwood, Lancs. — wishes to borrow.

C.R.O. TUBE 5CP1, Data and Pin Connections, Cossor Telecheck & Marber Generator, 1322 — R. G. Barlow, 3 Wray Close, Beverley, E. Yorks — Service Manual to purchase or borrow.

Rx B40, Rx208, Rx 1132, also using Tubes VCR97 or 5FP7 as oscilloscopes — A. J. Gaunt, 12 Potland, Leeming Bar, Northallerton, North Yorks. DL7 9BA — any information.

In your work-shop

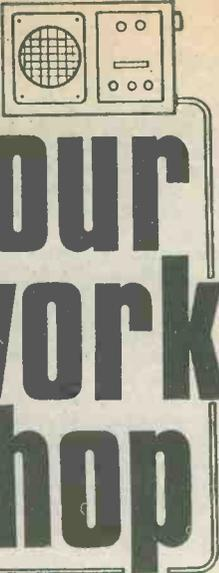

Inspiration struck the Serviceman. "Now, why on earth didn't I think of that before?"

"Think of what?"

"Why, readers' hints, of course," stated Smithy cheerfully. "It's over a year since we last had a session on readers' hints, and no end have come in since then."

Dick's face brightened immediately.

"Now that really is a good idea," he said warmly, as he carried his stool over to Smithy's bench. "Just what we need to round off the day. Smithy, you're a genius!"

"I have my moments," responded Smithy modestly, as he bent over and opened the door of the cupboard under his bench. "Let's see what awaits us this time."

Taking out a sheaf of letters, he straightened up and placed them on his bench.

"We'll go straight into the first hint," he announced, opening the top letter in the pile. "This one is for a home-made heat sink."

Smithy took two drawings from the letter and placed them on the bench. (Figs.1(a) and (b).)

"That heat sink," commented Dick, "looks as though it's made for a TO3 transistor."

"It is," confirmed Smithy. "You start off with a piece of aluminium 1 to 1.5mm. thick and measuring 80mm. square, and then you drill and cut it as shown in the drawing. You'll notice that the holes are either 7mm., 4mm., or 3mm. but, for convenience, they could be all one size, say 5mm. The four holes marked 'A' are not vital, but they help to speed up things and make the bends more accurate. You can see how the heat sink looks after bending in the second diagram. Neat, isn't it?"

This month Smithy the Serviceman, in company with his assistant Dick, takes a break from work to discuss the latest batch of hints received from readers.

"Battleships?" queried Smithy.

Dick groaned.

"I'm fed up with battleships. Besides, I always win."

"That," accused Smithy, "is because you draw in the darned ships while the game is going on. How about a little session with Scrabble then? I think I've still got the board and letters knocking around in my cupboard."

"Scrabble causes too many arguments."

"How come?"

"Well, you make up queer technical words I've never even heard of and you say that all my words are either spelled wrong or rude."

"Perhaps it does cause a lot of arguments," conceded Smithy. "What annoys me most is that you even misspell the rude words."

Dick sprawled ungracefully against his bench.

"Why don't we just shut up shop and go home?"

"We've got to stick it out until packing-up time," replied Smithy. "We may have cleared up all the work for today, but there's no knowing that a last-minute job may not turn up."

READERS' HINTS

Dick gazed mournfully out of the window at the brightly lit July scene outside.

"A whole half-hour," he moaned. "A whole half-hour with nothing to do."

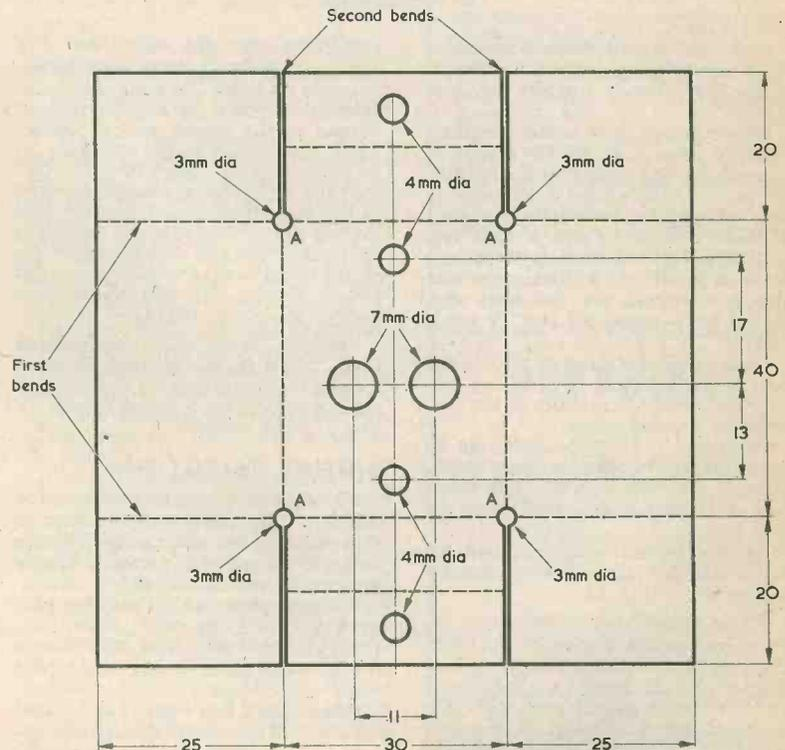

All dimensions in mm

(a)

Fig. 1(a). First steps in making up a heat sink for a TO3 transistor. The material is aluminium sheet

(b). The heat sink in its final form

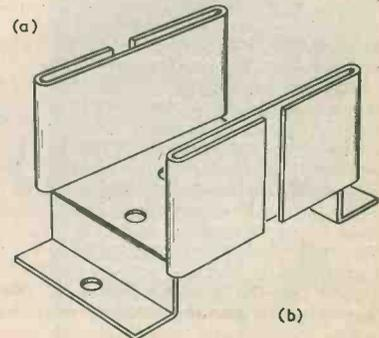

(b)

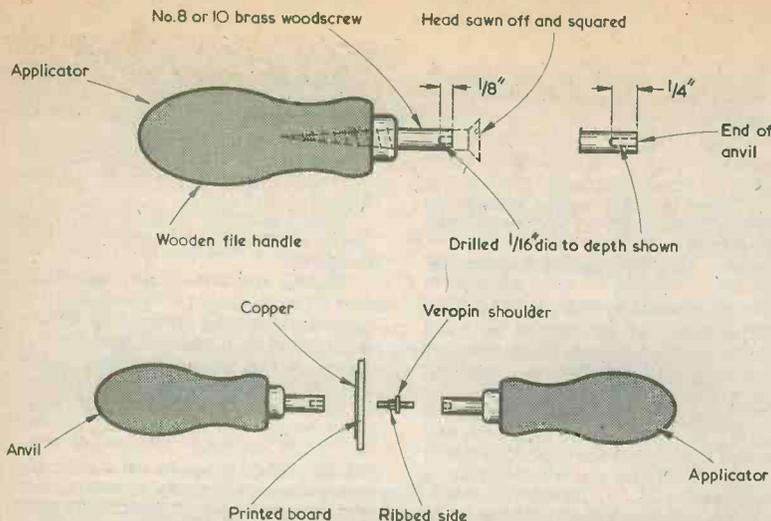

Fig. 2. Two simple home-made tools which may be employed for the insertion or removal of terminal pins in printed circuit boards or Veroboards

"I'll say," agreed Dick. "I'm not too clued up on aluminium thickness in millimetres, though. I'm an s.w.g. man myself!"

"Fair enough," said Smythy equably, reaching for a group of papers clipped together at the back of his bench. "Let's have a look at my wire tables. I said 1.5 to 1mm., didn't I? Well, 1.5mm. is just a little less than 16 s.w.g. and 1mm. is almost exactly equal to 19 s.w.g. So the aluminium used for the heat sink should be between 16 and 19 s.w.g. Okay?"

"Sure," replied Dick. "What's the next hint, Smythy?"

Smythy looked carefully at the new letter he had taken up.

"Actually," he said slowly as he read, "there are two hints here. There's a sketch as well, illustrating both of them. Let's start off with the first hint."

Smythy placed the sketch on his bench and pointed to the appropriate section of it. (Fig. 2).

"The idea here," he went on, "concerns a pair of tools for the insertion of double-sided Veropins into printed circuit boards or Veroboards, and they work equally well with pins intended for Veroboard of 0.1 inch matrix and pins intended for Veroboard of 0.15 inch matrix. One tool is an applicator and the other is an anvil. Each tool is made up in the same way with the exception of the final hole which is drilled in it. First, a brass woodscrew is screwed into a wooden file handle, its head is sawn off and the end is squared up. A hole is then drilled centrally in the end of the screw shank, the hole being deeper in the anvil than it is in the applicator."

"How do you use these tools?"

"You first," said Smythy, consulting the letter, "insert the pin, ribbed end first, into the board hole with your fingers. The anvil is placed over the emerging tip of the pin and the

applicator over the other end. The applicator is then used to push the pin home in its hole. The tools allow considerable force to be exerted without danger to the board, and a distinct 'click' can be felt as the pin takes up its final position. Apart from the fact that the tools ensure proper insertion of the pin, there is also the fact that the pin can be fitted even in the midst of closely packed components. An added bonus is that, if you reverse the tools, pins can be withdrawn from similarly crowded boards."

"Blimey, that's neat," commented Dick. "First thing tomorrow I'll start looking for a couple of file handles and some woodscrews. I could do with a pair of those tools."

SIGNAL INJECTION

"I should imagine," chuckled Smythy, "that you'll have the urge to make quite a few other gadgets before we get to the end of this session. Take a look at the second sketch."

Smythy pointed at the drawing with his finger. (Fig. 3).

"It looks," said Dick, "as though it's basically a coil wound on a ferrite rod."

"And that's just what it is," stated Smythy. "It's intended for signal injection."

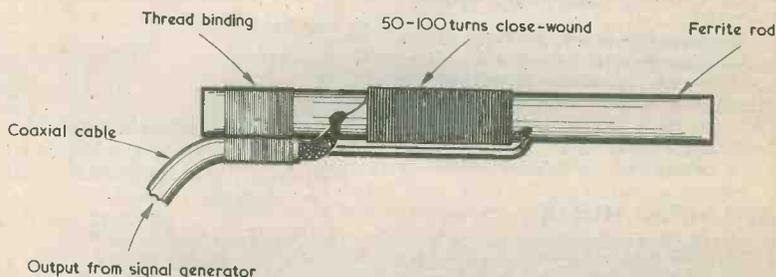

Fig. 3. A signal injector which eases alignment problems with a.m. receivers covering medium and long waves. It may also be employed for "trawler band" alignment

tion when lining up medium and long wave radios. A lot of receiver service sheets specify quite long-winded procedures for signal injection, and there isn't even agreement on procedure between different manufacturers. Our correspondent feels that the alignment signal should enter the receiver by the same route as any other signal, by way of the aerial. And that explains the purpose of this device."

"What," asked Dick, "is the length of the ferrite rod?"

"It's not critical," stated Smythy. "Anything between 3 and 6 inches of so will do. The coil consists of 50 to 100 turns of enamelled wire of between 26 and 34 s.w.g. close-wound direct onto the rod. If available, a ready-wound medium wave aerial coil would be quite suitable. A screened cable from the signal generator output is held against the ferrite rod by a binding of thread, and its braiding connects to the near end of the coil and its centre lead to the far end. Insulating tape is then wound over the coil and the connections. Medium and long wave signals are injected into the receiver by placing the ferrite rod, with its coil, alongside the ferrite rod in the set. A very effective control of injection level is given by varying the spacing between the two rods. The aerial and oscillator circuits can then be trimmed and padded by setting the signal generator to the appropriate frequencies. I should add that the injector can also be used on the 'trawler band' as well as on medium and long waves."

"Can you use it for lining up the i.f. transformers?"

"Oh definitely," said Smythy. "The intermediate frequency with these a.m. sets is almost invariably between 450 and 480kHz, which is only a little lower than the low frequency end of the medium wave band. So if you tune the set to the low frequency end of that band it is quite easy for an intermediate frequency from the signal generator to bludgeon its way through to the collector of the mixer. You then align the i.f. transformers in the normal manner."

"Humph," said Dick thoughtfully. "It looks as though I'd better start looking for an odd ferrite rod and some enamelled wire as well tomorrow."

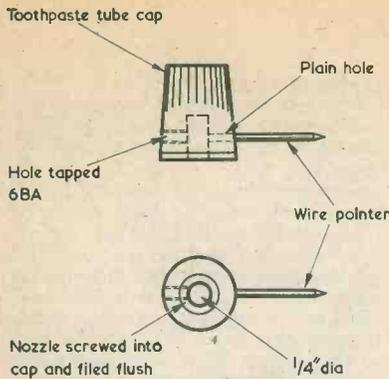

Fig. 4. Yet another use for toothpaste tube caps! In this instance the cap functions as a small control knob with a wire pointer

"Fair enough," grinned Smithy, turning to the unopened letters. "Hallo, I've got two envelopes clipped together here. Now, why did I do that? Oh yes, I remember! These are two separate hints sent in at different times by the same reader. Let's have a look at the first."

Smithy opened the envelope and a small knob with a pointer fell out. (Fig. 4.)

"Ah," said Smithy with a smile, "we're back on the old toothpaste tube cap jag here. Sometimes I think toothpaste manufacturers design their screw-on caps solely so that they can be modified for use in electronics!"

"This one," commented Dick, turning the knob over in his fingers, "certainly seems to be a presentable item."

"Yes, it's quite smart, isn't it?" replied Smithy, consulting the letter. "The reader concerned, who lives well away from component shops, wanted one small knob to complete a job and he didn't feel like paying postal costs for this from a mail order supplier. The hole in the nozzle of many toothpaste tubes is $\frac{1}{4}$ inch in diameter and so he cut off the nozzle of a used tube and screwed it into the cap. He then drilled a hole all the way through a diameter of the cap and nozzle, and tapped this 6BA in one wall. This takes a 6BA grub screw. A piece of wire pushed into the untapped hole on the other side then functions as a pointer."

"That's a neat idea."

"I suppose," said Smithy, "that before you come in tomorrow you'll be scouting around at home looking for empty toothpaste tubes."

"I collect them!"

"You do what?"

"I collect them," repeated Dick.

"What on earth for?"

"I wait until someone starts lighting a fire in his garden and I throw them, with their caps screwed on tight, into that. It's quite fascinating seeing them all swell up and go off pop!"

"I'm sorry I asked now," said Smithy hastily. "Let's turn to the second hint from this reader."

He opened the second envelope and read its contents.

"Now this is quite a crafty idea," he remarked. "The reader points out that you can make a very useful, strong and inexpensive metal box from two 2-ounce tobacco tins. You add a hinge at one long side so that the two boxes hinge together. The long side which opens can then be held closed by a small strip of springy brass soldered inside one half and engaging with the rolled-over inside edge of the other half. Here's the idea."

Smithy showed Dick a sketch in the letter. (Fig. 5.)

"Now who," pondered Dick aloud, "do I know who buys pipe tobacco in 2-ounce tins?"

"The two tins," remarked Smithy, returning to the letter, "make quite a respectably sized box, measuring about 4 by 3 by 2 inches. This will take a surprising amount of components, including a $2\frac{1}{2}$ inch speaker and a PP3 battery."

PRINTED CIRCUIT DESIGN

The Serviceman turned to a further letter.

"Hallo," he remarked, "here's another letter with two hints in it. The first is concerned with the design of printed circuit boards. For this you use double-sided graph paper which is ruled with lines having a matrix of 0.1 inch. The secret of the success of this idea is that the lines printed on both sides of the paper should coincide, so that they appear as single lines when the paper is held up to the light."

"I think I can guess what's coming next," stated Dick slowly. "Do you draw the component layout on one side of the paper and the copper layout on the other?"

"You do," confirmed Smithy. "The piece of graph paper then forms a true pictorial representation of the printed circuit design. You can start by working out the component layout, after which you draw a frame around the components to represent the edges of the board. Next you turn the paper over, draw in a corresponding frame and join the various circuit points together. This represents the copper side of the board and you can always check the combined results by holding the paper up to a light."

"That 0.1 inch matrix will be useful

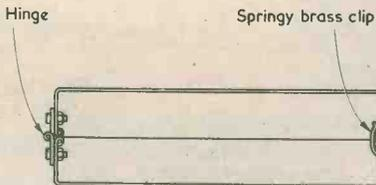

Fig. 5. A useful and inexpensive metal box can be formed by combining two 2-ounce tobacco tins in the manner shown here

Your Local Supplier

LONDON

THE MODERN BOOK CO.

Largest selection of English & American radio and technical books in the country.

19-21 PRAED STREET,
LONDON, W2 1NP
Tel: 01-723 4185/2926

ESSEX

MORSE IMPROVEMENT

C90 Cassettes 1-12 w.p.m. with simple exercises. 12-14 w.p.m. computer produced professional level operator material including international symbols.

Price: complete with instruction and exercise booklets £4 including postage. Overseas £1 extra.

Morse Key and Buzzer Unit suitable for sending practice and DIY tape preparation.

Price £4 including postage. Overseas £1 extras.

MHEL ELECTRONICS (R)

12 Longshore Way, Milton,
Portsmouth (UK), PO4 8LS

SUSSEX

JEFFRIES

For
Hi-Fi Equipment
Tape Recorders
Television
Transistor Radios

6A Albert Parade
Victoria Drive,
EASTBOURNE SUSSEX

EIRE

PEATS for PARTS

ELECTRONIC COMPONENTS RADIO & TELEVISION

For the convenience of Irish enthusiasts we supply:

Radio & Electronics
Constructor Data Books
Panel Signs
Transfers

Also a postal service

PEATS

the world of electronics
25 Parnell Street, Dublin 1. Telephone 749972

for working out connection points for d.i.l. integrated circuits, won't it?"

"It will," agreed Smythy. "Which represents another of the advantages of the scheme. A word of warning is required here, however, because graph paper with an 0.1 inch matrix is becoming rather difficult to obtain, although when you can get your hands on some it will last a good long time. The alternative is graph paper with a 2mm. matrix, which is all right in every other respect except that it doesn't agree with i.c. pin spacing. Whatever type you use, the end result can be a very neat and tidy layout, both on the component and the copper sides of the board."

"First thing tomorrow . . ."

"Don't worry about it," interrupted Smythy. "I've got quite a few sheets of 0.1 inch matrix graph paper knocking around somewhere. I'll let you have it in the morning. I might even be able to find you some doublesided Sellotape."

"What will I need that for?"

"This next hint," replied Smythy, as he continued to scan the letter. "You can use the tape, which is sticky on both sides, to hold the turns of a coil in place when these are wound with a single layer of thin wire. A turn or two of the tape is wrapped around the coil former and the wire is then wound on the exposed sticky surface of the tape. The resulting coil will be a bit lossy because the adhesive won't be a perfect insulator, but if this doesn't matter the idea certainly guards against the tendency of the wire to spring undone or move along the former."

"Gosh, Smythy," said Dick, "we're certainly dealing with plenty of hints in this session."

"We are indeed," agreed Smythy, picking up a further letter. "What is more, this next letter adds no less than another four. They're all short ones, and I'll read out the first one right now. It is often necessary to try different resistor or capacitor values in a circuit where continual soldering is impractical or where the physical positioning of the component is important. In such a case two Soldercon sockets, as normally used for i.c.'s, can be soldered in, whereupon the lead-outs of the resistor or capacitor can simply be plugged in to these. The lead-outs are cut to size and shaped, of course, before insertion. You could also use three Soldercon sockets if you wanted to be able to plug in different transistors."

Dick frowned.

"I'm not too clear," he announced, "what exactly Soldercon sockets are."

"They come in single insulated strips with 0.1 inch spacing," explained Smythy. "You cut off the length of strip you require and you normally plug integrated circuits pins into the sockets. Now here's the second hint in this letter and again I'll read it out directly. 'It is sometimes difficult to fit stand-off insulators in crowded or miniature layouts, or on the inside of an outside panel. A solution consists of

cutting out a small square of printed circuit board, with a side of about $\frac{1}{4}$ inch, and sticking it to the chassis or panel with the copper side outwards. Connections can then be made to this low profile insulator.' There's a sample in the envelope."

Smythy took out a small piece of printed board with several wires soldered to it and passed it over to Dick. (Fig. 6.)

"Why, that's just the job," exclaimed Dick, picking up the sample. "Particularly if you have a layout which would otherwise necessitate one or more mid-air joints."

"Very true," stated Smythy. "Now here's the third hint. 'An excellent substitute for s.r.b.p. tubing for coil formers is the rigid plastic pipe used for domestic water systems. The sizes, between $\frac{1}{2}$ inch and 2 inches in diameter, are suitable for many coils in receivers, transmitters and test equipment."

As Smythy was reading from the letter, Dick pulled out the Serviceman's note-pad towards him and started scribbling furiously.

"I'll next," went on Smythy, absorbed in the letter, "read out the last hint in this letter. 'Plugs and sockets for plug-in coils are becoming difficult to find in the old styles. A solution is to use a DIN plug stripped of the outer plastic and metal case, this being cemented into the coil base. Only the section actually carrying the pins is used and it can, of course, be either the 3-pin or 5-pin version as appropriate. The plug fits into a DIN socket in normal manner."

Smythy placed the letter on top of the pile he had already dealt with, then reached for a fresh one.

"We're certainly getting plenty to think about today," commented Dick, as he waited expectantly. "What's in

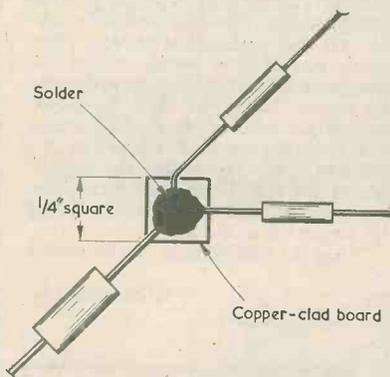

Fig. 6. A low profile stand-off insulator for crowded chassis layouts. The copper-clad board is glued to a chassis or panel, copper side outwards, and provides an anchor point for component lead-outs and wires

that letter, Smythy?"

"A very simple hint," responded the Serviceman, "together with an idea which is really more in the form of a suggestion than a hint. Despite its simplicity the hint is extremely useful. The letter points out that sheets of fibreglass can be obtained very cheaply or even free from car breakers who deal with lorries and vans, including in particular ex-G.P.O. vehicles. Many of these have fibreglass roofs, etc., which the average breaker has no use for and is glad to get rid of. Our reader has used this material very successfully for circuit boards, and also for constructing boxes, housings and cabinets. A glass-fibre and resin car repair kit can be used on the inside of a cabinet, and a very neat and professional-looking job results."

FUTURE TASKS

"I'm going to be pretty busy in the future," remarked Dick. "After I've been to the plumber's for plastic pipe, I'll have to hunt around for a friendly neighbourhood car breaker!"

"You don't have to take advantage of all these hints straight away," protested Smythy. "Some of them are schemes which will be of assistance to you when you encounter a problem later on."

"Not with me they aren't," stated Dick firmly. "When I encounter a good idea I like to take advantage of it straightaway."

"Well, have it your own way," responded Smythy mildly. "I'll proceed next to the suggestion in this letter. 'In common,' says the writer, 'with many other enthusiasts I have a sizeable collection of integrated circuits which have been mainly removed from computer and surplus panels. Most of these are entirely useless to me as they bear unfamiliar type letters and numbers which I am unable to find in any reference book, nor can I ascertain the manufacturer. How would it be if someone with the necessary knowledge were to start up a postal identification and data service? For a reasonable fee, the service would undertake to identify and supply data for up to 10 devices sent through the post. Preferably, of course, on a no identification-no fee basis! Some such service would be a godsend to people like myself and could show a good profit to the person operating it.'"

"Blimey," said Dick, impressed, "that is a good suggestion. The chap who operated a service like that would need mainly to know the internal house numbers used by the individual manufacturers, as well as have the necessary technical knowledge."

"Let's," said Smythy impatiently, "get on to the next hint."

"No, hang on a minute. How about us operating a service like that? You could sort out the integrated circuits and I'd do the paperwork, packing and posting!"

Smythy shuddered at the prospect.

"No way," he remarked emphatically. "Apart from the fact that the idea of entrusting paperwork to you is too terrifying to contemplate, I find it difficult enough to identify some of the more recent devices even when they have the standard type numbers on them. The letters and numbers are getting so tiny that a magnifying glass has now become part of my normal servicing equipment!"

Dick sighed, as he relinquished his vision of a future Workshop in which Smithy toiled endlessly at the identification of integrated circuits whilst he packed them and totted up the cheques and postal orders.

"Perhaps you're right," he agreed reluctantly. "Still there must be someone surely who would like to set up a service like that."

"There may well be," stated Smithy. "Well, the next hint is one of another set of four from a single reader, so I'll press on with them. Here's the first, and it applies to a very cheap audible continuity tester. This functions by breaking the battery connection to a transistor radio and inserting two test leads and prods in series. The radio is switched on and tuned in with the prods touching each other and the prods can then be used for continuity testing in multi-core cables and things like that. The radio plays whenever there is continuity between the test prods. A little experimenting with various fixed resistors will soon indicate the highest resistance which will allow an indication of continuity to be given."

"How do you make the connections into the battery?"

"Well," said Smithy, "If the receiver battery consists of single cells in series you can cut out a small circle of double-sided printed circuit board and solder one test lead to one side and the second test lead to the other side. The printed board may then be in-

serted between two of the cells. This is possible, of course, when these are in a battery holder having sufficient travel in its contact springs. If the battery used has connectors, such as those on a PP9 battery, you can connect one test lead to a male connector and the other to a female connector. This will then allow the test leads to be inserted in series with the battery." (Fig. 7)

As he spoke, Smithy was subconsciously aware that Dick was making an entry in the note-pad. However, he was too interested in the hints he was dealing with to pay any serious attention to the activities of his assistant.

"Now, here's the next hint," he resumed. "And it deals with the situation where you need a captive nut on the inside of a steel or aluminium chassis. It is difficult if not impossible to solder the nut in place directly to the chassis and so a neat solution consists of first soldering the nut to a circle of tinplate with a hole in the middle and of then fixing the tinplate to the chassis with Araldite or a similar strong adhesive." (Fig. 8.)

"That's a good idea," commented Dick. "Particularly if the chassis is too thin or too soft to take self-tapping screws."

"True," said Smithy. "And in any case self-tapping screws should not be used if the screw is to be removed and re-inserted a number of times. This idea would also enable you to fit a captive nut on the inside of a plastic cabinet."

"Oh, I never thought of that."

"That's why these hint sessions are so useful," remarked Smithy. "One idea very often sparks off another idea. Now, the third hint in this group shows how printed circuits can be employed to produce very striking notices and nameplates and things like that. You clean a piece of copper laminate board of the required size

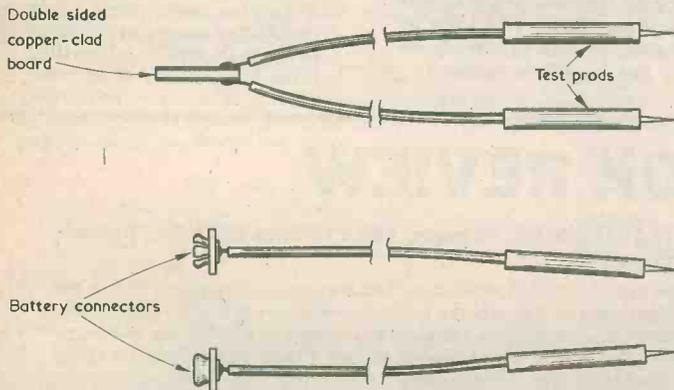

Fig. 7. An inexpensive audible continuity tester is given by inserting two test leads and test prods in series with the battery supply to a transistor radio. If the radio battery consists of individual cells in series, the double sided copper-clad board may be inserted between two cells. With batteries of the PP9 class the test leads are terminated in battery connectors.

GAREX

2-metre RECEIVER NR56: fully tunable 144-146 MHz, also 11 xtal positions for monitoring specific channels. Compact, sensitive, ideal for fixed or mobile listening. Built-in L.S., 12v DC operation. £54.00 inc. VAT. Crystals, if required: £2.41 each. All popular 2m. channels in stock. Credit terms available, s.a.e. details. Experimenters H.T. transformer: multitap primary, 5 sec. windings: 35V 200mA, 75/115V 150mA, 50V 500mA, 150V 300mA, 170/220V 300mA, Wt. 6kg. £5.50
Relays: GPO type 2400 (medium size): 200+200 Ω coil (12-24V), 8A contacts. 4PCO+1M Type 3000 (large): 2k Ω coil (24V) 1B+3M, 2k Ω coil (24V) 2PCO, 8A contacts. 100+100 Ω coil (3-12V) 4PCO.

All new, 60p each, any 5+ : 40p
Neons min. wire end, 55p/10; £4/100
Slide Switches min. DPDT 18p ea; 5+ : 14p
2 pole, 3 position 22p each; 5+ : 18p

Resistor Kits E12 series, 22 Ω to 1M Ω
57 values, 5% carbon film, $\frac{1}{4}$ W or $\frac{1}{2}$ W.
Starter pack, 5 each value (25p) £2.40
Mixed pack, 5 each $\frac{1}{4}$ W + $\frac{1}{2}$ W (570) £4.65
Standard pack, 10 each (570) £4.65
Giant pack, 25 each (1,425) £11.65

I.C.'s (new, full spec.) CD4001AE 25p
SN76660 75p NE555 55p 723(T05) 75p
SN76660 £1.12, 723 (T05) 90p

709 (T05), 741 (DIL-8) Op. amps 30p each
PL259 UHF Plug & Reducer 68p; 5+ : 60p
SO239 UHF Socket panel mt. 55p; 5+ : 45p
Nicad rechargeable cells HP7 size £1.05
each; 4 : 95p; 10+ : 88p. Brand new.

We stock amateur V.H.F. equipment and mobile aerials, s.a.e. details.

Distributors for J. H. Associates Ltd.
(switches and lamps)

PRICES INCLUDE UK POST, PACKING & VAT
Mail order only Sole Address:

GAREX ELECTRONICS
7 NORVIC ROAD, MARSWORTH,
TRING, HERTS HP23 4LS
Cheddington (STD 0296) 668684

MORSE MADE EASY

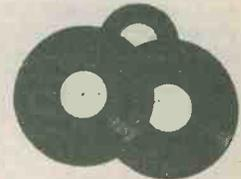

BY THE RHYTHM METHOD!

These courses, which have been sold for over 23 years, have been proved many times to be the fastest method of learning Morse. You start right away by learning the sounds of the various letters, numbers, etc., as you will in fact use them. Not a series of dots and dashes which later you will have to translate into letters and words.

Using scientifically prepared 3-speed records you automatically learn to recognise the code RHYTHM without translating. You can't help it. It's as easy as learning a tune. 18-V.P.M. in 4 weeks guaranteed.

The Complete Course consists of three records as well as instruction books. For Complete Course send £5.00 including P.P.I. etc. (overseas surface mail £1 extra).

THE MORSE CENTRE

Box 8, 45 Green Lane, Purley, Surrey.
I enclose £5.00 or large s.a.e. for explanatory booklet.

Name.....
Address.....

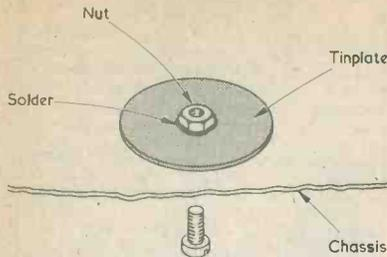

Fig. 8. How to fit a captive nut to an aluminium or steel chassis. The nut is soldered to a circle of tinplate with a hole in the middle, and the tinplate is then secured to the chassis with adhesive.

and apply the legend, using Letraset or similar pressure-sensitive lettering. Ensure that the letters are well stuck down by rubbing well over their protective backing paper. Remove the backing paper, then etch the copper away in a solution of ferric chloride in the usual way. Keep the etching time as short as possible since the Letraset does not form a perfect resist. Rinse and dry the board well, remove the lettering, then tin the copper letters which are left on the board, wiping away as much solder as possible in order that the solder has an even thickness."

"Stap me," remarked Dick. "That's a knobby way of going about things."

"Isn't it?" said Smithy. "Well, I'm afraid that we now come to the last hint of this present session. Our reader has a home-made transistor tester with three screw terminals for the emitter, base and collector. It is rather a tedious process connecting transistors to these terminals, particularly when a lot of transistors are to be checked. And so a scheme involving a printed board was devised. Here's the idea."

Smithy passed a further sketch over to his assistant. (Fig. 9.)

"That's the copper pattern on the board," he continued. "The three slots

at the top are fitted into the transistor tester screw terminals, which are then tightened down on the copper. A transistor is checked by holding its three lead-outs on the appropriate sections of the board, this providing quite an adequate connection for quick checks of current gain and leakage current. As you can see, the copper pattern caters for quite a range of lead-out configurations."

PARTS LIST

"And is that the last hint for today?"

"It is," said Smithy gravely as he gathered the letters together and returned them to his cupboard.

"Well now," said Dick thoughtfully, "I won't have to put printed circuit board on my list; I've got it down already."

At last, Smithy became fully aware

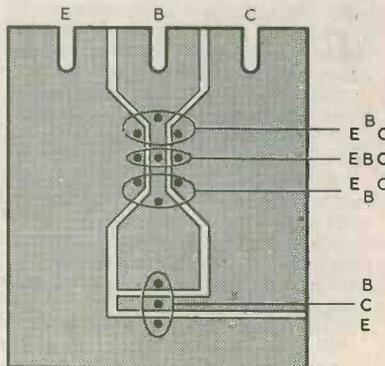

Fig. 9. This printed board permits quick testing of transistors, whose lead-outs are touched against the copper areas. The encircled dots show approximate connection points for different lead-out configurations. The slots at the top fit into terminals on the transistor tester.

that his assistant had been writing on the note-pad.

"What on earth are you doing there?"

"I've been making out a list," explained Dick. "A list of the things I intend getting in to try out these hints."

Smithy picked up the list and gazed at it incredulously.

"Well, you've certainly put enough items down," he said eventually.

"Let's see what you've entered. Araldite, tinplate, battery connectors, double-sided printed board, fibreglass, DIN plugs and sockets, plastic pipes, single-sided printed board, Soldercon sockets, double-sided Sellotape, 0.1 inch graph paper, 2-ounce tobacco tins, empty toothpaste tubes, enamelled wire, ferrite rod, two file handles, two brass woodscrews and 16-19 s.w.g. aluminium sheet!"

"That's it," stated Dick proudly.

"When you're as conscientious as I am you always make certain of getting your bits and pieces together before starting on anything."

"Well," chuckled Smithy, "seeing that this has been one of the best hint sessions we've had for quite some time I shan't accuse you of overdoing things."

Whereupon the pair, discovering that it was now twenty minutes after finishing time, rose, left and locked up the Workshop, leaving it undisturbed for the normal activities of the morrow and, at some much later date, yet another session devoted to the hints received from readers.

EDITOR'S NOTE

The hints described in this episode of 'In Your Workshop' were contributed, in the order in which they appear, by D. C. Wood, J. W. Robson, W. Puffett, J. Knapp, J. Kerrick, J. M. Pascoe and C. P. Finn.

Further hints for this feature are welcomed, and payment is made for all that are published.

And the answer to Smithy's resistor problem of last month? The resistance between X and Y is one-third R; the three resistors are in parallel.

BOOK REVIEW

BRITISH INDUSTRY TODAY — ELECTRONICS. 75 pages, 235 x 150mm. (9½ x 6in.) Published by H.M. Stationery Office. Price £1.40.

When all its sectors are taken together, the British electronics industry accounts for just over 5 per cent of the net output, and about 6 per cent of the exports, of all manufacturing industry in Britain. The British electronics industry is one of the largest and certainly the most comprehensive in Europe and the equal in most areas of technology to that of the United States. These statements are taken from the Introduction of "British Industry Today — Electronics", which has been produced by the Central Office of Information and is available at Government Bookshops and through booksellers.

The book deals with the entire field of electronics in Britain, ranging from the manufacture of resistors to the programming of computers. There is a mass of information covering costs, productivity and sales, with a review of the performances of the major companies and results achieved over recent years. Also provided are eight pages of photographs illustrating British electronic products and processes.

AMSAT - UK OSCAR COMMAND STATION

By Arthur C. Gee

The Amateur radio satellite OSCAR 6, which was launched in November 1972, was the first in what is hoped to become a series of long-life amateur radio communications satellites. Its lifetime was expected to be about one year, compared to previous OSCARs whose useful lives were limited to a few weeks only. Earlier OSCARs relied for their power on non-rechargeable power sources, whereas OSCAR 6 had rechargeable batteries, which derived their recharging current from panels of solar cells.

OSCAR 6 is still functioning, though it is beginning to show signs of wear and one at least of its battery cells has ceased to operate. Much of the credit for keeping it functioning so much longer than was expected is due to the activities of various Command stations, which are able to send signals to it to turn on or off certain operations aboard the satellite. The solar cells are not always able to supply sufficient current to maintain the battery charge when the satellite is under heavy use or is in partial sunlight orbits. In order to allow sufficient recharge periods, it has become necessary to switch the satellite off as required, and this is one function of the Command Stations. By attention to the Telemetry Signals from OSCAR 6 they are able to ascertain conditions aboard and send the appropriate signals to initiate the required functions. In this way the condition of the battery has been conserved and the life of OSCAR 6 greatly increased.

The 70cm and 2m Yagi antennas mounted on an azimuth and elevation antenna control unit to give access to OSCAR 6 on any desired orbit

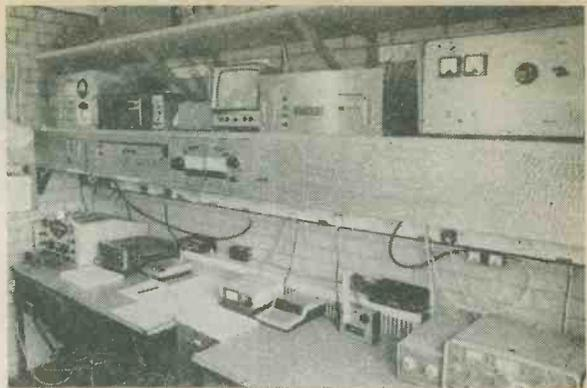

A general view of the Control equipment for OSCAR 6 in the Command station. Closed circuit TV is available for seeing the position of the antennas

Command of OSCAR 6 whilst over Western Europe is undertaken by the Command Station established at the University of Surrey. This facility was built by and is run by students in the Electronic and Amateur Radio Society in conjunction with the Department of Electronic Engineering.

To begin with a master clock was synchronised to the orbit time of OSCAR 6 and this was used to derive timing signals to switch on tape recorders which fed the appropriate commands to the transmitter and thence through a power amplifier to a yagi aerial. The aerial was steerable in azimuth only and hence gave only restricted coverage of orbits. Different commands could be preset for different times of day and days of the week, but this simple system did not provide the total control of OSCAR 6 necessary for satisfactory operation.

The second phase of the project was constructed around a 6 foot paraboloid aerial and a 4½ ton tracking mount. A control system was designed which gave both directional and elevation control. The motors take 30 amps at 30 volts, and two solid-state 900 watt servo-amplifiers with associated control electronics giving a proportional plus integral response enable the aerial to be positioned to within 1/20th of a degree. This antenna was lifted on to the tower in the spring of 1976 and 2 metre and 70cm crossed yagi aerials mounted on it, as shown in the accompanying photo.

In the two and a half years the University of Surrey Telecommand Centre has been operational, some six million commands have been despatched to OSCAR 6. Since the Phase 2 auto-command was commissioned, command acceptance reliability has been extremely good. Extensive tests have yielded 90% command acceptance by OSCAR 6 within 5 seconds and in most instances a single shot command will suffice. The Command code structure does possess an elementary error detection facility and occurrences of spurious responses to commands are rare.

Much help in conceiving and completing this project was received from numerous individuals associated with it; in particular Professor D. R. Chick, and the U.S. Department of Electronic Engineering; Storno; SMC Ltd.; STL; PLESSEY; MICROWAVE MODULES; ASWE and AMSAT-UK all helped with equipment.

The author is indebted to Martin Sweeting, Head of the Project, for his assistance in providing the notes and photographs, from which this article was compiled.

Trade News . . .

WALL MOUNTING FOR HI-FI SPEAKERS

The correct positioning of stereo and hi-fi speakers is a major factor in determining their effectiveness. In particular experts have for years exhorted the hi-fi owning public to mount speakers away from shelves, carpets etc. — yet often (dare we say it?) the message has fallen on deaf ears, largely through the lack of reasonably priced wall-mounting equipment.

Fidelity Fastenings have now plugged this acknowledged gap in the market with their FF1 Speaker Bracket Set. The FF1 set provides a really effective wall-mounting for a pair of hi-fi speakers with full audio-focus on the horizontal plane. Capable of supporting speakers of up to 23kgs (50lbs) in weight, the FF1 gives the added bonus of enabling the speaker to be removed from the wall in an instant, yet the speakers remain firmly mounted and insulated from vibration during actual use.

Available through radio and hi-fi dealers, the recommended price inc. VAT is £5.49, or £5.85 if posted.

Further information from the makers: Fidelity Fastenings Ltd., The Ridgeway, Iver, Bucks. SL0 9HW.

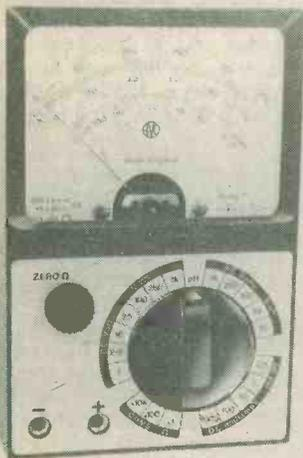

A new multimeter for the service technician, fitted with fail-safe fuse protection. Sensitivity of 20 kΩV to match test readings given in TV service manuals

AVO INTRODUCE AVOMETER MODEL 71

Avo announce the introduction of Avometer Model 71, a new updated version of their popular Model 72. Like its predecessor, the 71 incorporates the well-tried and proved thick film resistor technology and the very robust Avo centre pole movement. Since the introduction of the first of this range in 1972 many thousands have been supplied to Government authorities and private industry and retailer service departments all over the world.

Model 71 offers 21 ranges covering d.c. voltages from 0.15 to 1000V, d.c. current from 50μA to 1A; a.c. voltages from 10 to 1000V and resistance up to 20MΩ. Sensitivity is 20kΩ/volt d.c. and 1kΩ/volt a.c. with an accuracy of ±2.5% f.s.d. on all voltage and current ranges and a frequency response up to 100 kHz. Fail-safe fuse protection is fitted.

The instrument is easy to use and is supplied with a set of leads, prods and clips. Optional accessories include a carrying case, 30 kV d.c. probe and plug-in d.c. current shunts.

The dimensions of the instrument are 145 x 95 x 57 mm. which, together with the non-fragile polycarbonate plastic window and tough ABS case moulding, make it eminently suitable for professional use by trade field service technicians.

Distribution in the U.K. is through 25 Appointed Distributors and many other electrical and electronic wholesalers.

CONSTRUCTOR'S CROSSWORD — SOLUTION

ACROSS

1, Capacitance. 7, Baud. 8, Ammeter. 9, Dot. 10, Reach. 11, Geared. 13, Spread. 16, Apart. 18, Dud. 19, Hot-Head. 20, Item. 21, Chrominance.

DOWN

1, Charge. 2, Padder. 3, Coated. 4, Timer. 5, NOT gate. 6, Earthed. 11, Graphic. 12, Adapter. 13, Sudden. 14, Radian. 15, Ampere. 17, Therm.

SMALL ADVERTISEMENTS

Rate: 8p per word. Minimum charge £1.00
Box No. 20p extra

Advertisements must be prepaid and all copy must be received by the 4th of the month for insertion in the following month's issue. The Publishers cannot be held liable in any way for printing errors or omissions, nor can they accept responsibility for the *bona fides* of Advertisers. (Replies to Box Numbers should be addressed to: Box No. —, *Radio and Electronics Constructor*, 57 Maida Vale, London, W9 1SN.

WANTED: Large and small quantities of transistors, I.C.'s, displays, etc., etc., Call any Saturday to: 306 St. Paul's Road, London N.1. Telephone: 01-359 4224.

RESISTORS: E12, 5% 1/3 W — 1p. Diodes 4148 — 3p, 4004 — 5p, LM555CN — 38p. VAT inclusive. 15p postage. Cleveland Supplies, P.O. Box 20, Redcar, Cleveland.

SERVICE SHEETS for Radio, Television, Tape Recorders, Stereo, etc. From 50p and s.a.e. Catalogue 25p and s.a.e. Hamilton Radio, 47 Bohemia Road, St. Leonards-on-Sea, Sussex.

300 PAIRS OF S/H SPEAKERS in 9" x 14" teak cabinets. From £3.50. Edwards, 103 Goldhawk Road, London W12. Telephone: 743 6996.

THE RADIO AMATEUR INVALID & BEDFAST CLUB is a well established Society providing facilities for the physically handicapped to enjoy the hobby of Amateur Radio. Please become a supporter of this worthy cause. Details from the Hon. Secretary, Mrs. Rita Shepherd, 59 Paintain Road, Loughborough, Leics., LE11 3LZ.

ANTIQUÉ WIRELESS: For valves, radios, components and service sheets, 1920 to 1950. Contact The Vintage Radio Shop, 1977 Full Catalogue 70p. 64 Broad Street, Staple Hill, Bristol BS16 5NL. Telephone: (0272) 565472.

ELECTRONIC DEVICES and Semiconductors. Component kits for this month's projects. S.A.E. for lists. Export welcome. NKM, P.O. Box 65, Eastbourne, Sussex.

OUTSTANDING HI-FI FM TUNER. Comprises 7 transistor superhet design with vericap tuning, AFG. Latest silicon circuitry, full coverage 88-102MHz. Supplied built and tested with metal front panel and instruction sheet. Only £9.95 + 30p P. & P. Gregg Electronics, 86-88 Parchmore Road, Thornton Heath, Surrey.

SEND 10p IN STAMPS for latest list of aids for DX Listening, tuners, filters, etc. Stephens-James Ltd., 47 Warrington Road, Leigh, Lancs, WN7 3EA.

TV REPAIRS SIMPLIFIED. Full repair instructions individual British sets £4.50; request free circuit diagram. Stamp brings details of unique TV publications. Auserec, 76 Churches, Larkhall, Lanarkshire.

TREASURE HUNTERS! Construct 11-transistor metal detector giving £300 performance. 10 page illustrated plans. send £1. C. H. Lucas, 241 Upminster Road South, Rainham, Essex.

(Continued on page 771)

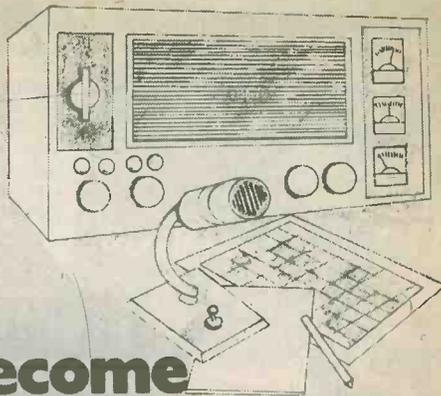

Become a radio amateur.

Learn how to become a radio amateur in contact with the whole world. We give skilled preparation for the G.P.O. licence.

WAA

Free!

Brochure, without obligation to: **BRITISH NATIONAL RADIO & ELECTRONICS SCHOOL,** P.O. Box 156, Jersey, Channel Islands. **REK 77**

NAME _____

ADDRESS _____ (Block caps please)

CUSTOM CABINETS

We build all types of loudspeaker enclosures, disco consoles, amplifier cases etc., to our designs or for your special requirements.

HOME CONSTRUCTORS

Professionally finish your equipment using our specialist fittings:

Recessed pocket handles approx W5¼" x H2¾" x D3" 38p each

Lifting bar recessed handle approx W6¼" x H10¾" x D2¾" £1.96 each

Corner protectors (black nylon) for rounded edges, supplied with screws and brads 11p each

Corner protectors (metal) 1½" for square edges, supplied with screws 10p each

Standard jack socket recessed mounting plate 9p each
Cabinet feet 1½" dia x ¾" high (black polyethylene) 9p each
Black "Vynfile" cabinet covering approx 52" wide £1.90 per yard

Black "Vynair" haffle covering approx 52" wide £2.60 per yard

1½" speaker fixing bolts, C/S with left-hand wood screw into baffle, including washers and nut. 2BA 5p each; 4BA 4p each

Pre-cut cabinet parts/baffles etc. price on application

Prices include VAT On orders under £5 please add 60p towards postage and packing

SURREY AUDIOTRONICS

51B LIND ROAD, SUTTON, SURREY

For expert advice

Tel: 01-643 0005

THE OPEN DOOR TO QUALITY



4th ISSUE INCLUDES NEW METERS AND SWITCHES as well as items from advanced opto-electronic components to humble (but essential) washers. Many things listed are very difficult to obtain elsewhere. The company's own computer is programmed to expedite delivery and maintain customer satisfaction. Attractive discounts continue on many purchases, Access and Barclaycard orders are accepted.

SEMI-CONDUCTORS ● COMPONENTS ● ACCESSORIES ● TOOLS
 * **FREE POSTAGE** on all C.W.O. mail orders over £2 list value (excluding VAT) in U.K., add 15p handling charge.

144 pages
40p
 Post paid
 inc. refund
 voucher
 worth
40p

All communications to Head Office, Dept. RC7 28 ST. JUDES ROAD, ENGLEFIELD GREEN, EGHAM, SURREY TW20 0HB. Phone Egham 3603 Telex 284475. Hours 9-5.30 daily; 1 pm Sats. NORTHERN BRANCH: 680 Burnage Lane, Burnage, Manchester M19 1NA. Phone 061-432 4945. Hours 9-5.30 pm, 1 pm Sats.

ELECTROVALUE LTD

PRINTED CIRCUITS AND HARDWARE

Comprehensive range Constructors' hardware and accessories. Sheet aluminium and lightweight sections. Selected range of popular components. Printed circuit boards for individual designs. Drawing materials for printed circuits. Resist coated laminate, epoxy glass for the d.i.y. man. Full processing instructions, no unusual chemicals required.

Send 15p for catalogue

Ramar Constructor Services

Masons Road · Stratford-on-Avon · Warwks CV37 9NF

MULLARD FERRITE CORES — LA3 100 to 500 kHz, 75p; LA5 30 to 100 kHz, 100p; LA7 10 kHz, 100p LA13 for W.W. Oscilloscope, £2.00.

SPECIAL OFFER — Metallised Polyester Capacitors by Erie, Mullard, etc. Values include: .01/160V, .01/250V, .015/160V, .022/160V, .033/160V, .047/160V, .068/160V, .1/160-250V, .22/160V, etc. This is a bargain not to be missed. 100 for £3.00.

1N4148 **SWITCHING DIODES**, 10 for 30p; 50 for £1.25; 100 for £1.50; 1,000 for £12.50.

TRANSISTORS — All branded BC147, BC148, BC149, BC157, BC158, BC159, BF194, BF195, BF196, BF197, 10p each or 100 for £7.50.

Please note all prices include UK Postage and appropriate VAT @ 8% or 12½%

XEROZA RADIO

306 ST. PAUL'S ROAD, HIGHBURY CORNER, LONDON N1
 Tel: 01-226 1489

SMALL ADVERTISEMENTS

Use this form for your small advertisement

To: The Advertisement Manager, Data Publications Ltd., 57 Maida Vale, London W9 1SN

Please insert the following advertisement in theissue of RADIO & ELECTRONICS CONSTRUCTOR

➔			

15 words at 8p
 = £1.20

**ALL WORDING
 IN
 BLOCK LETTERS
 PLEASE**

I enclose remittance ofbeing payment at 8p a word. MINIMUM £1.00
 Box Number, if required, 20p extra

NAME.....
 ADDRESS.....

Copy to be received four weeks prior to publication. Published on the 1st of every month.

SMALL ADVERTISEMENTS

(Continued from page 769)

BOOKS TO CLEAR: *Introductory Radio-Theory and Servicing*, 1948 (With Teacher's manual) by H. J. Hicks, £1.50. *Klystron Tubes*, by A. E. Harrison, 1947, £1.50. *An Approach to Audio Frequency Amplifier Design*, 1957, G.E.C. Publication; £1.25. *Television Engineers' Pocket Book*, 1954, by Molloy & Hawker, 50p. All prices include postage. — Box No. G329.

FOR SALE: 108-136MHZ Receiver. Size 5in. x 3in. x 2in. Pocket size. Easily adjusted to tune over 144MHz band with good sensitivity. £16.50 post and packing paid. Romak Engineering Ltd., Dept. RE, 10 Hibel Road, Macclesfield, Cheshire SK10 2AB.

60kHz MSF RUGBY RECEIVERS BCD time-of-day output. High performance PLL 5V operation, pulsating LED. Kit or assembled instrument available. Prices £14.08-£23.47. Details: Toolex, Sherborne, Dorset.

WANTED URGENT. Power Supply unit or circuit for frequency meter BC221. Hamilton, 67 Caswell Close, Farnborough, Hants.

JOIN THE INTERNATIONAL S.W. LEAGUE. Free services to members including Q.S.L. Bureau, Amateur and Broadcast Translation, Technical and Identification Dept. — both Broadcast and Fixed Stations, DX Certificates, contests and activities for the SWL and transmitting members. Monthly magazine, *Monitor*, containing articles of general interest to Broadcast and Amateur SWLs, Transmitter Section and League affairs, etc. League supplies such as badges, headed notepaper and envelopes, QSL cards, etc., are available at reasonable cost. Send for League particulars, Membership including monthly magazines, etc., £3.75 per annum. (U.K. and British Commonwealth), overseas \$10.00 or £4.00. Secretary ISWL, 1 Grove Road, Lydney, Glos., GL15 5JE.

WANTED: To purchase April 1975 issue of *Radio & Electronics Constructor* in good condition. Offers? Box No. G333.

MICRO SWITCHES button type, 3A 250V. Minimum quantity 5 for £1 all inclusive. Cobra Electronic Systems Ltd., 83 Greenfields Avenue, Alton, Hants.

FOR SALE: R/E, E/E, P/W. 75 in all. From October 1974. Best offer. R. Plant, 5 Molyneux Place, Stoke, Plymouth, Devon.

WANTED: Desk-FAX machine, complete or spare parts, with literature, manuals, etc., in the series TR100/1 and TR102/1, made by Creed & Co. Ltd. Details to Box No. G335.

JUBILEE PACKS. Contains diodes, transistors, capacitors, resistors, plus odd items. Average 80 items per pack. £1 plus 25p P. & P. Cheque or P.O. to: A. Callow, 61 Coniston Way, Bewdley, Worcs.

FOR SALE: A loft full of surplus components. Speakers, uniselectors, wire etc. Must be cleared. Also Fidelity tape recorder, Meccano set and electronics construction kit. Offers? Telephone: 01-455 0248 evenings.

(Continued on page 773)

PLAIN-BACKED NEW STYLE SELF-BINDERS

for your other magazines

(max. format 7½" x 9½")

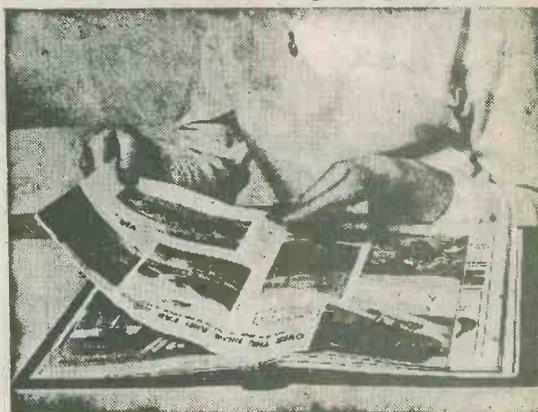

The "CORDEX" Patent Self-Binding Case will keep your copies in mint condition. Issues can be inserted or removed with the greatest of ease. Specially constructed Binding cords are made from Super Linen of great strength, very hard twisted and twice doubled. They are attached to strong RUSTLESS Springs under tension, and the method adopted ensures PERMANENT RESILIENCE of the Cords. Any slack that may develop is immediately compensated for, and the Cords will always remain taut and strong. It is impossible to overstretch the springs, as a safety check device is fitted to each.

COLOURS: MAROON OR GREEN

(If choice not stated, colour available will be sent)

PRICE £1.15 P. & P. 30p

Owing to heavy demand please allow
27 days for delivery

Available only from:—

Data Publications Ltd.
57 Maida Vale London W9 1SN

**Essential
for the
Short Wave
Enthusiast**

THE RADIO AMATEUR OPERATOR'S HANDBOOK

**13TH
EDITION**

**MAKE SURE
OF YOUR
COPY
NOW!**

**88 PAGES
ONLY
70p**

P. & P. 12p



- ★ AMATEUR PREFIXES
 - ★ AMATEUR CODES
 - ★ LOCAL TIME CONVERSIONS
 - ★ 8 MAPS
 - ★ FREQUENCY/WAVELENGTH CONVERSION TABLES
 - ★ POST OFFICE REGULATIONS
- MANY OTHER ESSENTIAL ITEMS

SIMPLE SHORT-WAVE RECEIVERS

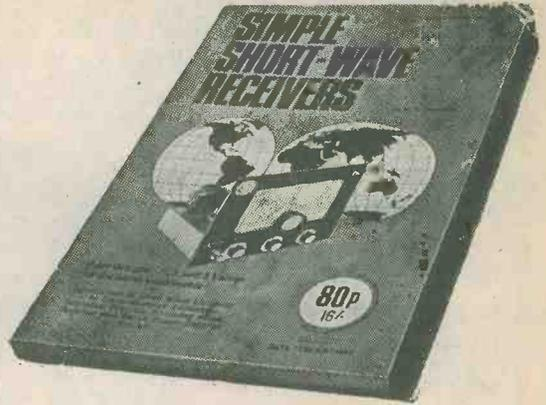

If you are interested in the hobby of receiver construction and short wave listening this is the book for you. It covers the whole field of s.w.l'ing from construction to operating – both Broadcast and Amateur bands. It explains how the circuits work, how to assemble the parts, how to wire-up the circuits with point-to-point wiring diagrams, step-by-step instructions and how to test and operate the completed projects.

by F. A. Baldwin

- ★ FOUR DESIGNS -
1, 2 and 3 Valves
 - ★ INTRODUCTION TO SHORT WAVE LISTENING -
14 Comprehensive Sections
 - ★ WORKSHOP PRACTICE
 - ★ SOLDERING NOTES
 - ★ RECEIVER AND BENCH POWER SUPPLIES
- etc. etc.

140 Pages **80p** P. & P. 18p

TO DATA PUBLICATIONS LTD 57 Maida Vale London W9 1SN

Please supply copy(ies) of "Radio Amateur Operators Handbook", Data Book No. 6

Please supply copy(ies) of "Simple Short Wave Receivers", Data Book No. 19
(Please tick which book is required)

I enclose cheque/crossed postal order for

NAME

ADDRESS

BLOCK LETTERS PLEASE

SMALL ADVERTISEMENTS

(Continued from page 771)

FOR SALE: Complete 9.5mm cine "Wide screen" outfit — Cameras, projector, screen, etc. S.A.E. for details. Box No. G336.

POSTAL ADVERTISING? This is the Holborn Service. Mailing lists, addressing, enclosing, wrapping, facsimile letters, automatic typing, copy service, campaign planning, design and artwork, printing and stationery. Please ask for price list. — The Holborn Direct Mail Company Capacity House, 2-6 Rothsay Street, Tower Bridge Road, London, S.E.1. Telephone: 01-407 6444.

WANTED: Radio & Electronics Constructor wave-winding machine copy. Replies to Box No. G337.

FOR SALE: *Radio & Electronics Constructor* January 1962 to December 1976 (4 copies missing) also *Practical Wireless* January 1969 to December 1976 (3 copies missing). Offers to: Croxson, 37 Canterbury Avenue, Ilford, Essex, IG1 3NA.

FREQUENCY LIST TRANSFERS. We have a limited supply of sheets of Dial Frequency Transfers in black. Short Wave frequencies 1.8Mc/s to 32Mc/s and 144Mc/s and 146Mc/s. Includes amateur band marker frequencies at 100kc/s points and other short wave frequencies from 2 to 32 Mc/s at every 500Kc/s points. Each frequency is repeated. Two sheets for 5p., five sheets for 10p., postage 7p. Data Publications Ltd., 57 Maida Vale, London, W9 1SN.

FOR SALE: Copies of "Hi-Fi News" January 1975 to October 1975 inclusive, plus December 1975 and January 1976. Mint condition. Offers? Box No. G338.

FOR SALE: 741 25p, NE555 42p, AC128 10p, BC107/8/9 9p, TIL209 12p, 2N3819 30p, UT46 30p, IN4001 5p. All inclusive. Delos Electronics, 76 Ber Street, Norwich, Norfolk.

BARGAIN COMPONENT PACKS. Capacitors: Mullard electrolytic and printed circuit mounting; Resistors: most ratings and wire-wound also v.d.r.'s. Less than 1p per item. Pack sizes: 90p and £1.60p with post and packing inclusive. Limited quantity only. Send P.O. today to: Eddie Richards, 8 Grove Road, Leighton Buzzard, Beds.

PERSONAL

JANE SCOTT FOR GENUINE FRIENDS. Introductions to opposite sex with sincerity and thoughtfulness. Details free. Stamp to: Jane Scott, 3/Con North St. Quadrant, Brighton, Sussex, BN1 3GJ.

IF YOU HAVE ENJOYED A HOLIDAY on the Norfolk Broads, why not help to preserve these beautiful waterways. Join the Broads Society and play your part in determining Broadlands future. Further details from: — The Hon. Membership Secretary, The Broads Society, "Icknield," Hilly Plantation, Thorpe St. Andrew, Norwich, NOR 85S.

SPONSORS required for exciting scientific project. Norwich Astronomical Society are building a 30" telescope to be housed in a 20' dome of novel design. All labour being given by volunteers. Already supported by Industry and Commerce in Norfolk. Recreational. Educational. You can be involved. Write to: NAS Secretary, The Manse, Back Lane, Wymondham, Norfolk.

REVOR OPTICAL & TECHNICAL

42 TAVISTOCK STREET
LONDON W.C.2
Tel. 01-836 4536



£10.00

**POST
FREE**

4" dia. lens

FLEXIBLE MAGNIFIER

WITH CAST IRON BASE,
PRECISION GROUND-AND
POLISHED LENS, CHROME PLATED
FRAME AND FLEXIBLE TUBE.
IDEAL FOR HOBBIES, AND
DETAILED WORK WHICH REQUIRES
BOTH HANDS FREE.

CALLERS WELCOME

(Subject to price ruling at the time of issue)

18 watts of power at 240 v. straight to the bit

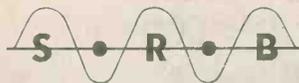

MINIATURE SOLDERING IRON

IDEAL for HOBBY or TRADE

SAFE: Complies with Consumer Protection Regulations BS No.3456 2/14

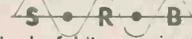
The  has a new method of bit-securing (pat. pending) and a built-in suspension hook.

All parts are very easily replaced.

Insulation tested at 1500 V. ac.

BIT SIZES:

19 (1.5 mm) 20 (3.0 mm)
21 (4.5 mm) 22 (6.0 mm)

PRICES: (including VAT and P and P)

IRONS £3.70 each. **BITS 41p** each
(Bit type 20 fitted as standard).

Cheques/P.Orders to Manufacturers and Distributors:

S. & R. BREWSTER
86-88 UNION ST · PLYMOUTH Tel

Ltd

0752-65011

Trade Enquiries Welcome

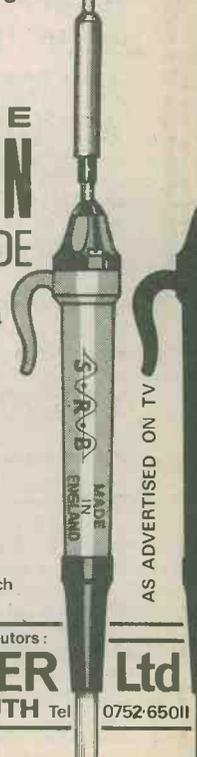

AS ADVERTISED ON TV

INDEX TO VOLUME THIRTY August 1976—July 1977

AMPLIFIERS

CMOS Audio Amplifier, by R. A. Penfold	551	Apl.	'77
Constant Current Audio Amplifier, by R. A. Penfold	288	Dec.	'76
General Purpose Pre-Amplifier, by F. G. Rayer	222	Nov.	'76
Simple Quadraphonic Amplifier — Part 1, by R. A. Penfold	671	June	'77
Simple Quadraphonic Amplifier — Part 2, by R. A. Penfold	753	July	'77
The "Port & Starboard" Stereo Amplifier — Part 1, by Sir Douglas Hall, K.C.M.G.	150	Oct.	'76
The "Port & Starboard" Stereo Amplifier — Part 2, by Sir Douglas Hall, K.C.M.G.	234	Nov.	'76
Versatile Power Amplifier, by J. P. Macaulay	26	Aug.	'76

AMPLIFIER ANCILLARIES

Audio Control Circuits — 2, Dynamic Noise Limiter, by P. R. Arthur	41	Aug.	'76
Audio Control Circuits — 3, Automatic Fader, by P. R. Arthur	91	Sept.	'76
Magnetic Cartridge Pre-Amplifier, by R. A. Penfold	420	Feb.	'77
Stereo Peak Level Indicator, by R. A. Penfold	488	Mar.	'77

ELECTRONICS

Battery Operated Timer, by R. S. Carlman	498	Mar.	'77
Bootstrapping, by D. Snaith	415	Feb.	'77
CD4018 Truth Tables, by G. A. French	668	June	'77
Car Battery Monitor, by F. T. Jones	425	Feb.	'77
Chip Resistors In Hybrid Circuits, by Michael Lorant	422	Feb.	'77
Current Mirror, by M. G. Robertson	362	Jan.	'77
Electronic Egg Timer, by P. R. Arthur	214	Nov.	'76
"Heads Or Tails?", by J. R. Davies	556	Apl.	'77
Hidden Resistance, by F. G. Lloyd	30	Aug.	'76
Jack Plug Key, by G. A. French	22	Aug.	'76
Light Operated Switch, by N. R. Wilson	475	Mar.	'77
Low Current Power Supply, by R. N. Soar	486	Mar.	'77
Mains Current Monitor, by G. A. French	284	Dec.	'76
Minimising Mains Hum, by D. Snaith	638	May	'77
Momentary Power Failure Indicator, by J. Knapp	309	Dec.	'76
Pins and Lead-Outs, by F. T. Jones	306	Dec.	'76
Precedence Detector, by D. Snaith	231	Nov.	'76
Relay Trigger Circuit, by G. A. French	88	Sept.	'76
Simple Random Selector, by R. A. Penfold	628	May	'77
Some Electronic Puzzles, by R. River	108	Sept.	'76
Sound Activated Switch, by R. A. Penfold	744	July	'77
Square Wave Generator, (Special Series-Blob-A-Job No. 2) by I. R. Sinclair	736	July	'77
4-Step CMOS Sequence Switch, by G. A. French	739	July	'77
Surge Currents, by R. J. Caborn	561	Apl.	'77
Switch-Off Pilot Light, by A. P. Roberts	610	May	'77
Switch-Off Reminder, by T. Miles	56	Aug.	'76
The CA3130 COS/MOS Op-Amp, by J. B. Dance	294	Dec.	'76
The "6-9" Game, by R. J. Caborn	346	Jan.	'77
The NOR Gate, by C. F. Edwards	102	Sept.	'76
Toytown Traffic Light Controller, by J. R. Davies	78	Sept.	'76
T.T.L. Sequential Switch, by G. A. French	340	Jan.	'77
Turning Transistors On, by J. M. Carstairs	404	Feb.	'77
Using Quad Norton Amplifiers, by A. P. Roberts	684	June	'77
Voltage Stabilizer, (Special Series-Blob-A-Job No. 1) by I. R. Sinclair	662	June	'77
12 Volt Motor Speed Controller, by R. A. Penfold	32	Aug.	'76

GENERAL

Amsat-U.K. Oscar Command Station, by Arthur C. Gee	767	July	'77
Antique and Wartime Radio, by Ron Ham	559	Apr.	'77
Antique Wireless Exhibition, by Ron Ham	211	Nov.	'76
Citizens' Band — Statement by R.S.G.B.	403	Feb.	'77
Constructor's Crossword, compiled by J. R. Davies	85	Sept.	'76
Constructor's Crossword, compiled by J. R. Davies	752	July	'77
500th Edition of World Radio Club, report by Ron Ham	539	Apr.	'77
Electronica 76 — a report, by David Gibson	418	Feb.	'77
Elliptical Cut-Out Marking, by V. C. Tondelier	614	May	'77
Forty-Seven and Still Going Strong, by Ron Ham	166	Oct.	'76
Historic Morse Key, by Ron Ham	25	Aug.	'76
International VHF Convention	55	Aug.	'76
Mobile Amateur Radio Log Requirements	558	Apr.	'77
Mounting Variable Capacitors, by R. J. Caborn	178	Oct.	'76
Novel Printed Circuit Assembly, by T. E. Millsom	733	July	'77
Octal and Binary, by D. Sheffield	282	Dec.	'76
Pioneers By The Sea, by Ron Ham	409	Feb.	'77
Pocket Noughts and Crosses, by David Gibson	680	June	'77
Producing Printed Circuit Boards, by P. R. Arthur	482	Mar.	'77
Radio Amateur Licences — Home Office Announcement	441	Feb.	'77
Relay Multivibrator, by D. W. Savage	343	Jan.	'77
Test Probe Clip, by H. Kennedy	502	Mar.	'77
The Beginnings of Electricity, by D. P. Newton	622	May	'77
The Oscar Satellite Programme, by Arthur C. Gee	361	Jan.	'77
The Paris Components Show, by David Gibson	742	July	'77
The Set in the Suitcase, by Ron Ham	511	Mar.	'77
U.S. Recording Centennial Stamp, by Michael Lorant	605	May	'77
Variable Capacitor Marking-Out, by V. C. Tondelier	493	Mar.	'77

IN YOUR WORKSHOP

A.M. Mixer — Oscillator Stage	370	Jan.	'77
CMOS Log 'c	243	Nov.	'76
Column L.E.D. Voltmeter	180	Oct.	'76
Electronic Dice	300	Dec.	'76
Humar. Reaction Timer	699	June	'77
Magic Maths Monitor	505	Mar.	'77
Readers' Hints	761	July	'77
Rejuvenating Early Radios	116	Sept.	'76
Seven-Segment Displays	50	Aug.	'76
Smithy's Crossword	444	Feb.	'77
Stereo Record Player Repair	632	May	'77
TV Repair	570	Apr.	'77

RECEIVERS

3-Band Short Wave Radio, Part 1, by A. P. Roberts	14	Aug.	'76
3-Band Short Wave Radio, Part 2, by A. P. Roberts	106	Sept.	'76
Integrated Circuit T.R.F. Tuner, by F. G. Rayer	400	Feb.	'77
Medium and Dual Short Wave Radio, Part 1, by P. R. Arthur	598	May	'77
Medium and Dual Short Wave Radio, Part 2, by P. R. Arthur	690	June	'77
Medium and Long Wave Superhet, Part 1, by A. P. Roberts	470	Mar.	'77
Medium and Long Wave Superhet, Part 2, by A. P. Roberts	566	Apr.	'77
Medium Wave DX Superhet, Part 1, by A. P. Roberts	270	Dec.	'76
Medium Wave DX Superhet, Part 2, by A. P. Roberts	364	Jan.	'77
Phase Locked Loop F.M. Tuner, Part 1, by R. A. Penfold	224	Nov.	'76
Phase Locked Loop F.M. Tuner, Part 2, by R. A. Penfold	297	Dec.	'76
Regenerative Short Wave Superhet, Part 1, by F. G. Rayer	160	Oct.	'76
Regenerative Short Wave Superhet, Part 2, by F. G. Rayer	238	Nov.	'76
Simple Regenerative S.W. Radio, by A. P. Roberts	352	Jan.	'77
The "Academy" Stereo F.M. Tuner, Part 1, by R. A. Penfold	96	Sept.	'76
The "Academy" Stereo F.M. Tuner, Part 2, by R. A. Penfold	168	Oct.	'76
The "Jubilee" A.M.-F.M. Receiver, Part 1, by Sir Douglas Hall, K.C.M.G.	726	July	'77
The "M5" Pocket Receiver, Part 1, by Sir Douglas Hall, K.C.M.G.	546	Apr.	'77
The "M5" Pocket Receiver, Part 2, by Sir Douglas Hall, K.C.M.G.	625	May	'77
V.H.F. A.M. Superhet, Part 1, by D. F. W. Featherstone	430	Feb.	'77
V.H.F. A.M. Superhet, Part 2, by D. F. W. Featherstone	496	Mar.	'77

RECEIVER ANCILLARIES

Experimental Aerial Tuning Unit, by Henry Hatch	349	Jan.	'77
Medium Wave Preselector, by R. A. Penfold	406	Feb.	'77
Novel L.E.D. Stereo Beacon, by R. N. Soar	292	Dec.	'76

TELEVISION

The "Epicon" Camera Tube, by Michael Lorant	664	June	'77
TV Sound Adaptor, by James Kerrick	694	June	'77

TEST EQUIPMENT

Binary Resistance Box, by S. P. Swan	38	Aug.	'76
CMOS Crystal Calibrator, by R. A. Penfold	615	May	'77
CMOS Voltmeter, by R. A. Penfold	334	Jan.	'77
Constant Current Transistor Gain Meter, by G. A. French	219	Nov.	'76
Electrolytic Capacitance Meter, by G. A. French	411	Feb.	'77
Four Level Digital Voltmeter, by K. T. Wong	437	Feb.	'77
Linear Scale Ohmmeter, by G. A. French	157	Oct.	'76
Meterless Transistor Tester, by Bruce Woodland	534	Apl.	'77
Novel Transistor Tester, by A. P. Roberts	142	Oct.	'76
Phase Shift A.F. Signal Source, by G. A. French	480	Mar.	'77
Polarity/Base Resolver, by G. A. French	542	Apl.	'77
Tone-Cancelling Capacitance Bridge, by W. R. Jenkins	110	Sept.	'76
T.T.L. Calibration Generator, by A. P. Roberts	206	Nov.	'76
Unijunction Signal Injector, by N. R. Wilson	94	Sept.	'76
Universal Battery Checker, by G. A. French	608	May	'77
Using Quad Norton Amplifiers, by A. P. Roberts	684	June	'77
Wide Range A.C. Millivoltmeter, by B. S. Wolfenden	276	Dec.	'76

CAN ANYONE HELP?

427	Feb.	'77	760	July	'77
-----	------	-----	-----	------	-----

LETTERS

639	May	'77
-----	-----	-----

NEWS AND COMMENT

20	Aug.	'76	86	Sept.	'76	148	Oct.	'76	212	Nov.	'76
280	Dec.	'76	344	Jan.	'77	398	Feb.	'77	478	Mar.	'77
540	Apl.	'77	606	May	'77	666	June	'77	734	July	'77

NEW PRODUCTS

177	Oct.	'76	449	Feb.	'77	504	Mar.	'77
-----	------	-----	-----	------	-----	-----	------	-----

RADIO TOPICS

57	Aug.	'76	113	Sept.	'77	312	Dec.	'76	640	May	'77
375	Jan.	'77	512	Mar.	'77	576	Apl.	'77			

RECENT PUBLICATIONS AND BOOK REVIEWS

37	Aug.	'76	242	Nov.	'76	410	Feb.	'77	693	June	'77
			766	July	'77						

SHORT WAVE NEWS

48	Aug.	'76	104	Sept.	'76	175	Oct.	'76	236	Nov.	'76
286	Dec.	'76	359	Jan.	'77	428	Feb.	'77	494	Mar.	'77
564	Apl.	'77	612	May	'77	678	June	'77	750	July	'77

TRADE NEWS

29	Aug.	'76	90	Sept.	'76	147	Oct.	'76
285	Dec.	'76	369	Jan.	'77	501	Mar.	'77
563	Apl.	'77	698	June	'77	768	July	'77

ELECTRONICS DATA

No. 13	What Inductors Do	...	iii	Aug.	'76	No. 19	Meter Shunts	...	iii	Feb.	'77
No. 14	Transistor Configurations	...	iii	Sept.	'76	No. 20	Potentiometers	...	iii	Mar.	'77
No. 15	T.R.F. Receivers	...	iii	Oct.	'76	No. 21	Screening	...	iii	Apl.	'77
No. 16	Superhet A.M. Receivers	...	iii	Nov.	'76	No. 22	Emitter and Collector Currents	...	iii	May	'77
No. 17	Germanium and Silicon	...	iii	Dec.	'76	No. 23	A.M. Detection	...	iii	June	'77
No. 18	Moving-Coil Voltmeters	...	iii	Jan.	'77	No. 24	Automatic Gain Control	...	iii	July	'77